

**RA**  **PA**

**TRANSLATED FROM  
ORIGINAL USER  
MANUAL**

**UPRIGHT REFRIGERATED CABINET  
WITH BOTTOM MOUNTED UNIT**

standard / *ecoline* / SR/WH

**EN**

**05/2021**

# Table of contents

---

1. Application and device code meaning	4
2. Product characteristics	5
3. Cooling system diagram	6
4. Wiring system	6
5. Wiring system diagram	7
6. Drawings	9
7. Positioning, start-up and operation	12
8. Maintenance	13
9. Transport and equipment	13
10. Temperature controller manual	14
11. Interferences	18
12. Notes	18



Please read this user manual carefully before using the device and keep it for future reference. Following the manual's recommendations guarantees long-lasting and failure-free exploitation of the device.



## IT IS FORBIDDEN

---

1. Make repairs on your own and fail to comply with the rules contained in this manual regarding the connection and operation of the device;
2. Store substances that may explode in the device, such as aerosols filled with combustible propellants;
3. Place the device in the sun;
4. Covering the inlet and outlet of air from the aggregate;
5. **Switching the device on to the mains without a properly functioning protective circuit system;**
6. Use of extension cords and dividers to connect power.
7. Connect the devices to the power socket without the protective pin.
8. Use devices/objects that could cause an electric spark inside the device and in the aggregate chamber.



## WARNING!

---

1. **Incorrect connecting of the device to the mains may result in an electric shock.**
2. In the event of sparks or breakdowns, immediately disconnect the device from the power supply by pulling the plug from the socket and calling an authorized service technician.
3. Efficiency of the protective circuit of the electrical system should be checked by an authorized electrician.
4. It is necessary to protect the wiring system and control system against water and mechanical damage.
5. When servicing and replacing parts, the device must be disconnected from the power supply

## CAUTION!

---



1. Before cleaning the condenser – **switch the device off!**
2. When cleaning the condenser, do not use tools/objects that could cause an electric spark.
3. Water condensation on glass panes and sheets at high relative humidity (over 60%) is a natural phenomenon. Long-term and frequent occurrence of dewing indicates inadequate ambient conditions and is not a basis for calling the service!
4. Take care when removing the glass panes. Breaking the glass panes can cause injury!



**The device is not intended for household use.**  
The device is not intended for outdoor use.

## 1. APPLICATION AND DEVICE CODE MEANING

The device is stationary-type equipment intended for storing and expose food products (previously cooled) at a reduced temperature.

### DEVICE CODE MEANING

Example of device code:

**4kl. SCh-Z/1600/NW**

**SCh** – type of equipment – upright refrigerated cabinet

**Z, ZR, S, 2S, SR, 2SR, 2S2R, 2S/1D** – refrigerator model

**NW** – stainless inside

**NZ** – stainless housing

**2N** – stainless inside and housing

**W** – fan assisted cooling (in SCh-S, SR models)

**4kl.** – 4<sup>th</sup> climatic class (standard – 3<sup>rd</sup> climatic class)







**WH** – increased capacity, increased height, with fan

**Width of the device [mm]:**

**625, 725, 825** – single-chamber

**1200, 1400, 1600** – double-chamber

**Important information on the rating label of each device:**

<b>UPRIGHT REFRIGERATED CABINET</b>			Name, logo and device type
Device type: <b>4kl. SCh-Z / 1600 / W</b>			
Serial no: XXXXXXXX	Voltage: 230 V ~ / 50 Hz		
Compressor no: XXXXXX/X	Rated current (A): XX		
Controller no: XXXXXXXX	Lighting power (W): XX		
Compressor type: XXXXXX	Weight (kg): XXX		
Refrigerant: HC-290	Usable capacity (l): XXX		
Refrigerant amount (kg): XXX	Climatic class: 4		
Equivalent of CO <sub>2</sub> (t <sub>refCO<sub>2</sub></sub> ): XX	Temperature scope (°C): +1 ÷ +10		
GWP factor: 3	Heater power (W): XXX		
Device technical parameters			
„RAPA“ sp. j. Ceramiczna 9 Street 20-148 Lublin POLAND tel. +48 81 718 53 46 50  www.rapa.pl			Manufacturer contact details
    			

In the case of contact with the service department, prepare the following data for efficient service:

- > device type,
- > serial no

Climatic class means the maximum ambient temperature at which the device works without disturbances.

Climatic class **3 / 4**

- > maximum permissible ambient temperature of **+25°C / +30°C**,

> temperature test:

ambient temperature **+25°C ± 1°C / +30°C ± 1°C**  
relative humidity **60% ± 3% / 55% ± 5%**

## 2. PRODUCT CHARACTERISTICS

- > rated voltage: **230V~ / 50Hz**
- > refrigerant: **HC-290**; ODP = 0, GWP = 3
- > working temperature: **+1°C ÷ +10°C**
- > sound pressure level: **<70dB (A)**



### Storage refrigerators

	Climatic class	Test parameters according to standard PN-EN ISO 23953-2	Air circulation	Z <input type="checkbox"/> <input type="checkbox"/>	ZR <input type="checkbox"/> <input type="checkbox"/>
Bottom mounted unit	3	Ambient temperature 25°C ± 1°C, relative humidity 60% ± 3%	static (gravity)	-	+
		Ambient temperature 25°C ± 1°C, relative humidity 60% ± 3%	dynamic (fan)		
	4	Ambient temperature 30°C ± 1°C, relative humidity 55% ± 5%	static (gravity)	+	+
		Ambient temperature 30°C ± 1°C, relative humidity 55% ± 5%	dynamic (fan)		

### Glazed refrigerators

	Climatic class	Test parameters according to standard PN-EN ISO 23953-2	Air circulation	S <input type="checkbox"/> <input type="checkbox"/>	SR <input type="checkbox"/> <input type="checkbox"/>	SR/WH <input type="checkbox"/> <input type="checkbox"/>	2S <input type="checkbox"/> <input type="checkbox"/>	2S <input type="checkbox"/> <input type="checkbox"/>	2S/1D <input type="checkbox"/> <input type="checkbox"/>	2S/1D <input type="checkbox"/> <input type="checkbox"/>	2SR <input type="checkbox"/> <input type="checkbox"/>	2SR/1D <input type="checkbox"/> <input type="checkbox"/>	2S2R <input type="checkbox"/> <input type="checkbox"/>	
Bottom mounted unit	3	Ambient temperature 25°C ± 1°C, relative humidity 60% ± 3%	static (gravity)	+	+		+	+	+	+	+	+	+	
		Ambient temperature 25°C ± 1°C, relative humidity 60% ± 3%	dynamic (fan)	+	+	+	+	+	+	+	+	+	+	+
	4	Ambient temperature 30°C ± 1°C, relative humidity 55% ± 5%	static (gravity)	+	+		+		+				+	
		Ambient temperature 30°C ± 1°C, relative humidity 55% ± 5%	dynamic (fan)	+	+		+		+				+	

Temperature range marking:

-	-1 ÷ +7°C
+	+1 ÷ +10°C

- single-chamber
- double-chamber

Product characteristic:

Width [mm] (A – fig. 1, p. 6)	Parameters			
	Usable depth [mm]	Usable width/depth of shelves [mm]	Usable capacity [l]	LED* power [W/m]
625	620	500/500	449	4,8
725	620	600/500	535	4,8
825	620	700/500	621	4,8
1200	620	500/500	898	4,8
1400	620	600/500	1070	4,8
1600	620	700/500	1242	4,8
<b>SR/WH</b>				
1200	620	500/500	954	4,8
1600	620	600/500	1333	4,8

\* - glazed refrigerators

### 3. COOLING SYSTEM DIAGRAM

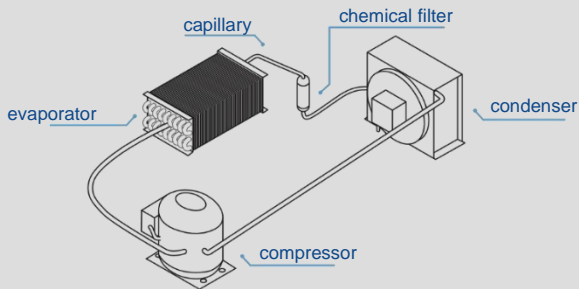

### 4. WIRING SYSTEM

1. The device is equipped with the protective PE cable.
2. Before connecting the device to the power supply, check the compatibility of the mains voltage with the device supplying voltage (data on the plate).
3. Connecting the device to the mains socket should be made so that the plug of the connecting cable is visible and easily accessible for the service.
4. The device should be connected to a separate, properly made electrical circuit protected by a fuse no greater than 10 A with a B-characteristic, ended with a socket with a protective pin.
5. The device may be started only after confirming the effectiveness of the shock protection with the results of measurements carried out in accordance with the applicable regulations.
6. Before carrying out any maintenance or cleaning, turn off the device with the switch and then remove the plug from the mains socket.
7. The device is started after connecting the plug to the mains socket, and then by turning on the switch. The backlight of the switch indicates that the device has been turned on.
8. Any repair of electrical installation and replacement of the connection cable (only into original one available from the manufacturer) may be carried out by an authorized electrician only.

## 5. WIRING SYSTEM DIAGRAM

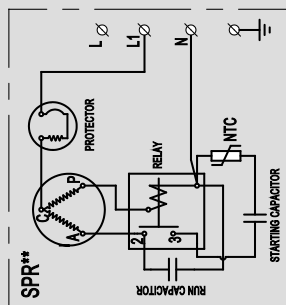
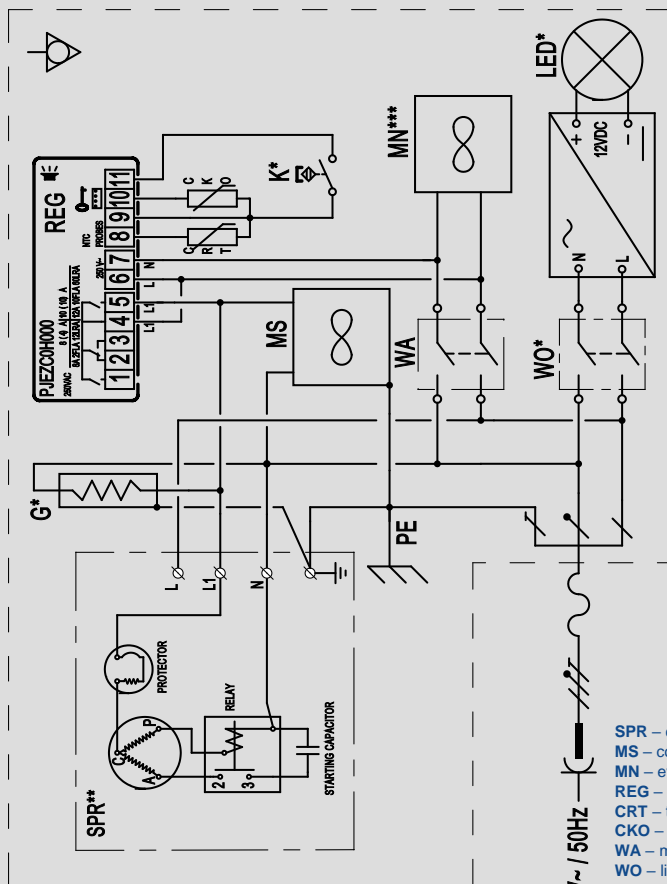

230V~ / 50Hz

- SPR – compressor
- MS – condenser fan
- MN – evaporator fan
- REG – electronic temperature controller
- CRT – temperature controller sensor
- CKO – defrosting completion sensor
- WA – main switch
- WO – lightning clip
- PE – protective clip
- G – PTC heater
- K – open door sensor

\* - optional equipment  
(lighting in models S, SR, 2S, 2SR, 2S2R, SR-WH as a standard)  
\*\* - type of the compressor depends on type of refrigerator  
\*\*\* - optional equipment  
in models S, SR, 2S, 2SR, 2S2R, in model SR-WH – as a standard

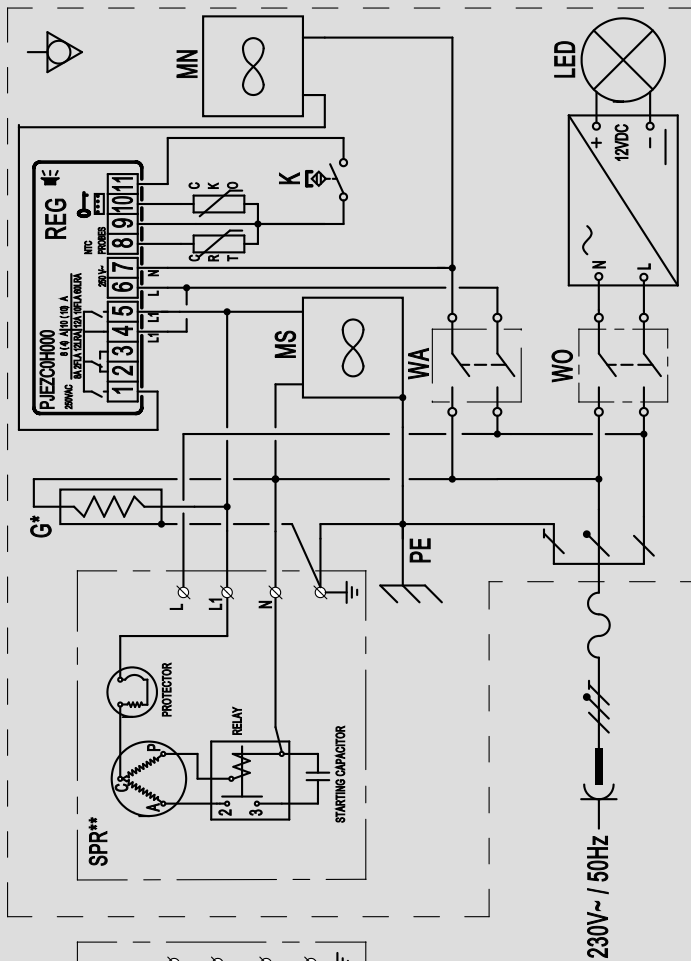

Electrical diagram of the device with fan switch and door open alarm.



## 6. DRAWINGS

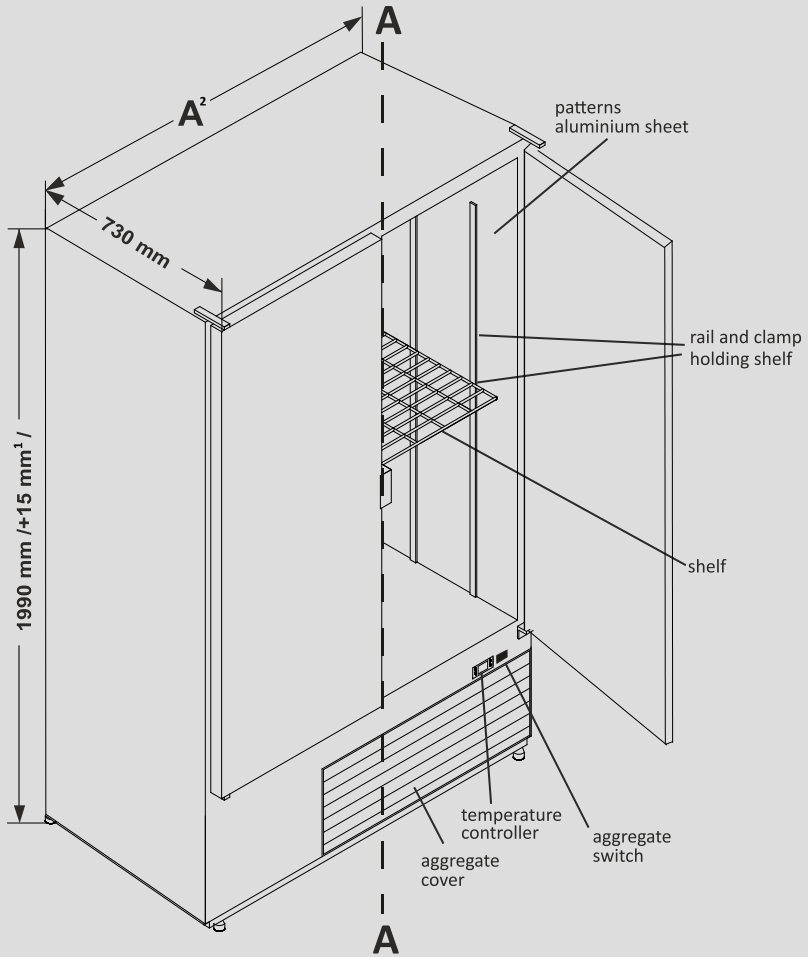

Fig. 1 EXAMPLE SKETCH OF ISOMETRY OF REFRIGERATOR MODELS: Z, ZR, S, SR, 2S, 2S/1D, 2SR, 2SR/1D, 2S2R

<sup>1</sup>) – legs adjustment

<sup>2</sup>) - width (dimension A) - table in point 2 User Manual

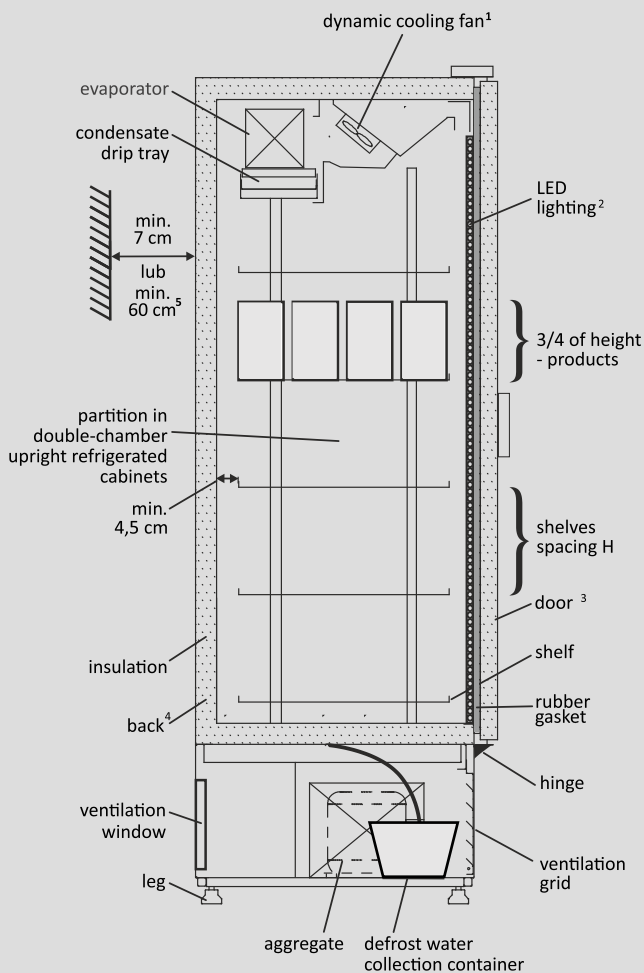

Fig. 2 EXAMPLE CROSS-SECTION (A-A) OF REFRIGERATOR MODELS: Z, ZR, S, SR, SR/H, 2S, 2S/1D, 2SR, 2SR/1D, 2S2R

\* - double-chamber refrigerators (Sch-1200, 1400, 1600) have a fixed partition

<sup>1)</sup> - it is not available in refrigerators type Z, ZR, and in models S, SR, 2S, 2SR, 2S2R – as additional equipment

<sup>2)</sup> – additional equipment in models Z, ZR

<sup>3)</sup> – doors in models Z, ZR – solid,

in models S, 2S, SR, 2SR, 2S2R – glazed

<sup>4)</sup> – back in models Z, ZR, S i SR – solid; in models 2S, 2SR, 2S2R – glazed doors (as an option fixed glass)

<sup>5)</sup> – the distance of 60 cm applies to models: 2S, 2SR, 2S2R

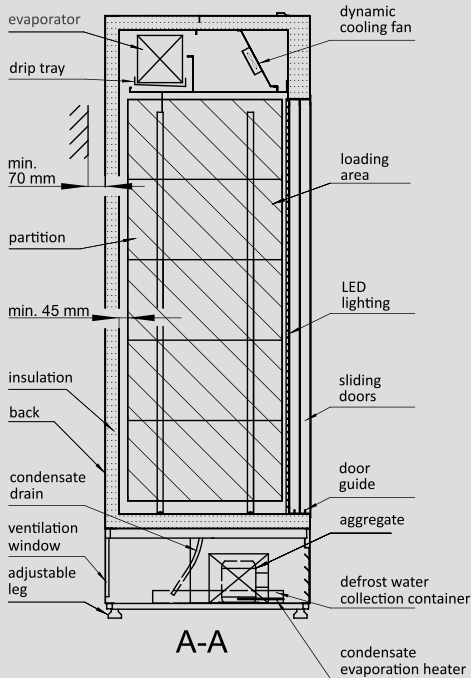
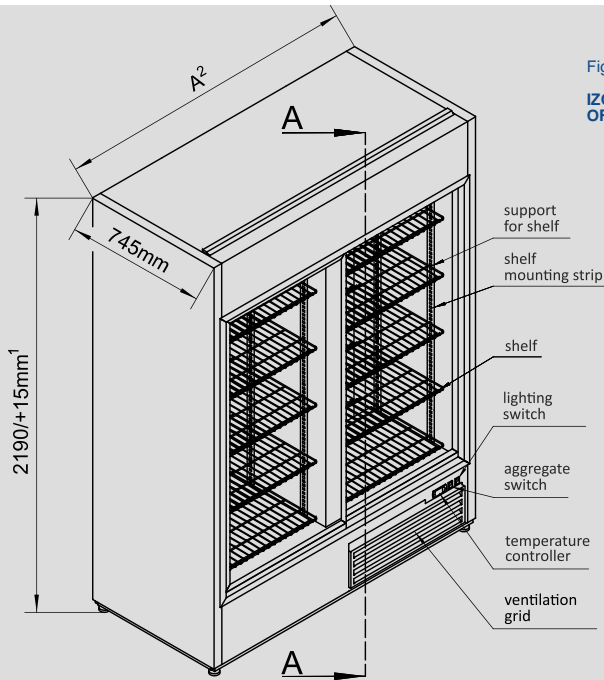

## 7. POSITIONING, START-UP AND OPERATION

To ensure proper operation, the device should be placed in an area with a good air circulation, away from heat sources and sunlight, free from dust (the device is not dustproof), at ambient temperature from +16°C to +25°C – 3<sup>rd</sup> climatic class, from +16°C to +30°C – 4<sup>th</sup> climatic class. **It is forbidden to cover the air inlet to the unit (1m) and the air outlet of the unit, keeping a distance from the wall of min. 7 cm (for models with glass on both sides - 60 cm).**The manufacturer is not responsible for interferences of the device operation in temperature beyond given range for 3<sup>rd</sup> or 4<sup>th</sup> climatic class. Place the device horizontally and connect it to the power supply according to the guidelines included in the chapter No. 4 - "Wiring system".

### **WARNING:**

**The device cannot be placed below the floor level (in a hollow).**

**The room in which the device is located must have a minimum cubature of 4 m<sup>3</sup>.**

### **Actions before start-up:**

Position the refrigerator in the required location and make sure all the feet are fully screwed home (almost as far as they can). Now unscrew the feet and, using a level, adjust the refrigerator until it is level. You can check whether it is level as follows: grip the refrigerator at the door side in the middle and lift it so that the feet do not touch the ground and then lower it. If both feet touch the floor at the same time when the refrigerator is being lowered, the level adjustment is correct.

In single-chamber refrigerators the door opens to the right (as standard). You can change the door opening direction by mounting the hinges on the left and turning the door upside down. The manufacturer is not responsible for any problems resulting from changing the door position; the user makes it at his own expense and risk. The manufacturer can make a refrigerator with the door opening to the left on request.

Place the shelves so that there is a free space (about 5 cm wide) between the rear wall of the refrigerator and the shelf edge to ensure proper air circulation.

### **ATTENTION:**

**NOTE: the door opening direction only from one side in the following models:  
2S – 625, 725, 825 MAY CAUSE THE REFRIGERATOR OVERTURNING**

### **NOTE:**

**In order to ensure proper air circulation, the goods should be placed on the lowest shelf – it is forbidden to place the goods directly on the bottom of the refrigerating chamber (the bottom is not designed to carry heavy loads).**

### **Start-up and exploitation:**

The cooling unit is switched on and off using the switch located over the protective cover. The temperature inside is adjusted by the thermostat, according to the instructions in p. 10. After switching the refrigerator on, leave it empty until it switches off for the first time. Now it is ready to be filled with products.

Place the products on the shelves so that they do not protrude behind the shelf contour – this is necessary to ensure proper air circulation inside. **The maximum shelf load is 30 kg for standard shelves and 40 kg for reinforced shelves.**

Never put warm/hot products in the refrigerator because this causes an extended temperature increase inside the refrigerator and can even create a fault.

## 8. MAINTENANCE

After disconnecting the device from power supply, the general maintenance should be done by the user, as follows:

1. washing with water of the temperature not more than +40°C with addition of natural cleaning agents. **To wash and clean the device it is forbidden to use agents containing of chlorine and sodium of various varieties, which destroy the protective layer and components of the device!** Any residual glue or silicone on the metal parts of the device should be removed only with gasoline (not applicable to plastic components!).

Do not use other organic solvents.

2. removing impurities from the condenser by means of vacuum cleaner **(from up to down - along the fins)** at least once a month so that the flow of the cooling air through the condenser fins is not hampered.

Not following the above instructions causes increased energy consumption, decreased refrigeration efficiency of the device and eventually result in aggregate overheating, which consequently may lead to failure.

**While cleaning the condenser be careful not to deform the fins. Do not wash the device with a water jet. It is not advisable to clean the condenser with a brush as it causes impurities penetration deep into the condenser fins and finally block the air flow completely.**

For units with an automatic condensation evaporation system, clean the sump (fig. 2 and 4) every 2 weeks to prevent the formation of unpleasant odours.



CLEAN THE CONDENSER WITH A VACUUM CLEANER HERE!

## 9. TRANSPORT AND EQUIPMENT

The supplied refrigerator is completely assembled. Secure the refrigerator during transport to prevent its overturning and damage to the paint coating. When handling the refrigerator do not grab the door or protective cover to lift the device. It is best to use belts and place them under the frame, between the feet (so that the belts do not slide). Do not lift the refrigerator directly with a forklift truck or a pallet jack without a pallet.

During transport and installation of the device, pay attention not to damage the cooling system, and before connecting the device to the power supply, make sure that the pipes of the cooling circuit are not damaged. In the event of damage to the cooling system, do not approach the device with a source of open fire or any other factor that may initiate ignition.

**The device must be transported in its operating position!**

**The refrigerator comes with:** user manual, additional condensate container, set of shelves: 5 pcs. or 10 pcs., shelf supports, door handles

## 10. TEMPERATURE CONTROLLER MANUAL

### DISPLAY DESCRIPTION

The display is three digits with decimal point and 6 symbols (compressor, fan, defrost, AUX, alarm and clock).

#### 1. COMPRESSOR

The symbol is visible when the compressor operates. It flashes when the compressor's start up is delayed because of protective procedure. It flashes in the cycle: two flashes – break when there is continuous operation mode activated.

#### 2. FAN

The symbol is visible when there are evaporator fans switched on. It flashes when the fans start-up is delayed by means of external switching off or when there is other procedure in progress.

#### 3. DEFROST

The symbol is visible when there is defrost function switched on. It flashes when the defrost start-up is delayed by means of external switching off or when there is other procedure in progress.

#### 4. AUX

The symbol is visible when there is additional AUX output activated.

#### 5. CLOCK

The symbol is visible when there is clock switched on – switching on by means of „tEn” switch or when there is time limit set. When switching on the symbols appears for few seconds as clock function availability.

#### 6. ALARM

The symbol is visible when there is alarm activated.

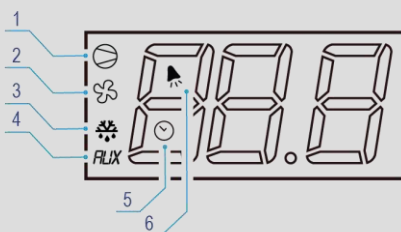

### SWITCHES DESCRIPTION

Information: Short pressing of any of the switches causes appearance of message related to the currently active function.

## 7. UP / ON OFF

During normal operation of the controller; pressed for longer than 3 sec. will cause change of controller ON/OFF operation state, pressed along with the “DOWN” switch at the same time for longer than 3 sec. will cause activation or deactivation of continuous operation function (after pressing there will be shown on the display “CC” symbol). In the parameters setting mode: enable going to the next parameters settings. During setting parameter values: it causes parameter value increase.

## 8. SET / MUTE

Pressed during normal controller operation switches the alarm sound signal off; pressed for longer than 3 sec. shows setting point; pressed along with the “DOWN” switch at the same time while switching power supply of the controller on will cause return to the parameters fabric settings (there will be shown “CF” symbol on the display). In the parameters setting mode: its pressing changes the information shown on the display: parameter name/parameter value, pressed for longer than 3 sec. will cause saving of the set parameters. During setting parameter values: pressed it will cause saving of the entered parameter value.

## 9. DOWN / DEFROST

During normal operation of the controller; pressed for longer than 3 sec. will cause switching on/off of the manual defrost mode. In the parameters setting mode: it allows to go to previous parameter setting. During setting parameter values: it decreases setting value.

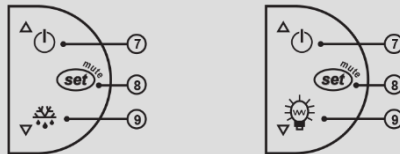

### Set point setting (desired temperature value)

To view and modify the set point:

- > press the “SET” switch for 1 sec. – the set value will start flashing;
- > increase or decrease the value using the “UP” or “DOWN” switches;
- > press the “SET” switch to confirm the new value

If the “SET” switch is not pressed for 60 sec., then the controller returns to previous settings.

## Manual defrost

In order to activate the manual defrost press the “DOWN” switch for more than 3 sec. The essential condition is the temperature has to be lower than +6°C.

## Temperature checking on the defrost probe

- > press the “SET” switch for longer than 3 sec. (in case there is the alarm is activated it is necessary to switch the sound alarm off first). On the display there will appear “PS” symbol (password);
- > go to the “d/” parameter be means of the “UP” and/or “DOWN” switches, then press the “SET” switch - there will appear temperature of defrost probe and the symbol ❄ or ⚙
- > hold the “SET” switch for longer than 3 sec. (after 60 sec. automatic return) – return to the temperature probe indication.

## Access for operator to parameters configuration and its modification

- > press the „SET” switch for longer than 3 sec. (in case there is alarm activated, switch the sound alarm first). On the display will appear the „PS” symbol (service parameter password protected);
- > go to the next parameters by means of the “UP” and/or “DOWN” switches;
- > press the “SET” switch to view the current value of parameter setting;
- > increase or decrease setting value by means of the “UP” and “DOWN” switches;
- > press the “SET” switch to temporarily save the entered new value – it will cause as well return to the parameters list;
- > repeat the above operations – if it is necessary;
- > press and hold the “SET” switch for longer than 3 sec. – it will cause parameters saving and exit from the programming procedure.

## Warning:

If no button is pressed for 60 sec., all the changes made to the parameters, temporarily saved in the RAM, will be cancelled and the previous settings restored. If power is disconnected from the instrument before saving the settings (pressing the “SET” switch for 3 sec.), all the changes made to the parameters and temporarily saved will be lost.

Symbol	Parameter	Unit	Fabric setting	min.	max.
d8	Alarm bypass time after defrost	h	2	0	15
A0	Alarm and fan temperature differential	°C	2	0	20
AL	Absolute or relative temperature for low temperature alarm	°C	2	0	150
AH	Absolute or relative temperature for high temperature alarm	°C	8	0	150
Ad	Temperature alarm delay	min	60	0	199

High temperature alarm activation = setting + AH  
High temperature alarm deactivation = setting + AH – A0

Low temperature alarm activation = setting – AL  
Low temperature alarm deactivation = setting – AL + A0



## Description of the main signals and alarms

**LED flashing** – The activation of the corresponding function is delayed by a timer  
> awaiting an external signal or disabled by another procedure that is already in progress. e.g. if is a continuous cycle in progress and a defrost is called, the latter will remain pending until the end of the continuous cycle, and the corresponding LED (defrost) will flash.

**OFF flashing – state of the controller - OFF, to return to working mode (ON) press and hold ON/OFF button for more than 3 sec.**

**E0 steady** – control probe error (1) – active sound signal:

- > probe not working: the probe signal is interrupted or short-circuited;
- > probe not compatible with the instrument.

The E0 alarm signal is constant when it is the only active alarm (the temperature value is not displayed).

**E0 flashing** – control probe error (1) – the alarm signal E0 is steady if it is the only active alarm (the temperature value is not displayed), while it flashes if other alarms are active or the second probe is displayed.

**E1 flashing** – evaporator probe error (2):

- > probe not working, the probe signal is interrupted or short-circuited;
- > probe not compatible with the instrument.

**Ed flashing** – The last defrost ended after exceeding the maximum duration rather than when reaching the end defrost set point. The message disappears when the next defrost ends correctly.

**EF displayed during operation or on power-up** – operating parameter reading error (controller automatic reset). Alarm reappearance after automatic reset – it is necessary to check the controller as there is no guarantee to keep the original precision of the operation.

**EE – data errors** – In certain operating conditions, the instrument may detect errors in the data saved. These errors may compromise the correct operation of the instrument. If the microprocessor detects a data saving error, the display shows the message “EE”. If the fault persists, the controller needs to be replaced. If, on the other hand, the message disappears, it can continue to be used. When “EE” error occurs frequently and/or remains for some time, the controller should be checked, as the original precision may not be guaranteed.

**LO flashing** – low temperature alarm. The probe has measured a temperature lower than the set point by a value that exceeds parameter AL:

- > check parameters AL, Ad and A0.

The alarm is automatically reset when the temperature returns within the set limits (see parameter AL).

**HI flashing** – high temperature alarm. The probe has measured a temperature higher than the set point by a value that exceeds parameter AH.

- > check parameters AH, Ad and A0.

## 11. INTERFERENCES

The most often occurring interferences of the device operation:

Reasons	Symptoms	Solution
<b>Contaminated condenser</b>	<ul style="list-style-type: none"> <li>&gt; Visible dust layer on the condenser fins,</li> <li>&gt; hot air coming out of the aggregate chamber,</li> <li>&gt; loud operation of the aggregate,</li> <li>&gt; characteristic "clicking" coming out of the aggregate chamber every few minutes</li> </ul>	Before cleaning of the condenser it is necessary to switch the device off. Impurities on the condenser should be removed by means of vacuum cleaner equipped with brush, gently along fins to not to bend the lamella.
<b>Device loaded with warm products</b>	<ul style="list-style-type: none"> <li>&gt; hot air coming out of the aggregate chamber,</li> <li>&gt; loud operation of the aggregate,</li> <li>&gt; characteristic "clicking" coming out of the aggregate chamber every few minutes</li> </ul>	Goods loaded in the device chamber should be initially cooled up to maximum +4°C above the storage temperature .
<b>Too high ambient temperature</b>	<ul style="list-style-type: none"> <li>&gt; hot air coming out of the aggregate chamber,</li> <li>&gt; loud operation of the aggregate,</li> <li>&gt; characteristic "clicking" coming out of the aggregate chamber every few minutes</li> </ul>	Ambient temperature for proper operation of the device should not exceed respectively: for 3rd climatic class +25°C.
<b>Improper goods distribution in cooling chamber</b>	<ul style="list-style-type: none"> <li>&gt; high temperature of products</li> </ul>	The goods should be placed as described in <b>user manual</b> .
<b>External source of heat causing the abnormal operation of the device</b>	<ul style="list-style-type: none"> <li>&gt; hot air coming out of the aggregate chamber,</li> <li>&gt; loud operation of the aggregate,</li> <li>&gt; characteristic "clicking" coming out of the aggregate chamber every few minutes</li> </ul>	External source of heat might be any other device that emits heat such as gas burner, heater, other device equipped with a refrigerated aggregate etc. It is necessary to pay attention if above mentioned examples may have influence on the deterioration of device operation conditions.

## 12. NOTES

1. Attempts to repair the device on your own and not following the instructions described in the user manual as for equipment connection and use will result in the device malfunction.
2. The device is using natural and ecological refrigerant R-290 (propane).



**Warning! In case of damage of the cooling system the refrigerator should be immediately disconnected from the mains, any open sources of fire located close to the unit removed and the area carefully ventilated.**

**Do not use electrical appliances inside the refrigerator.**

3. The manufacturer is not liable for damages resulting from the use of the device in a manner inconsistent with the information contained in hereby user manual.

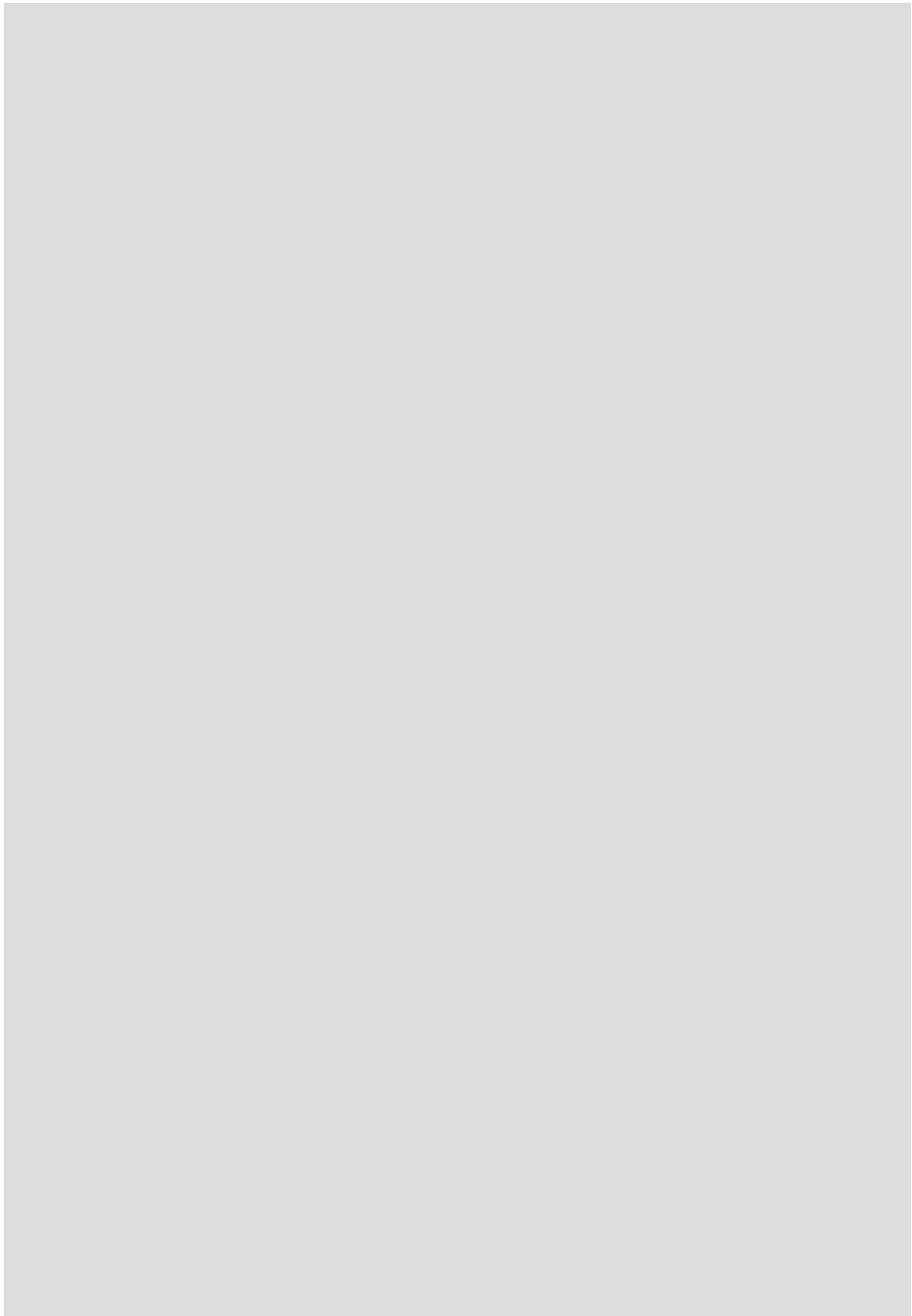

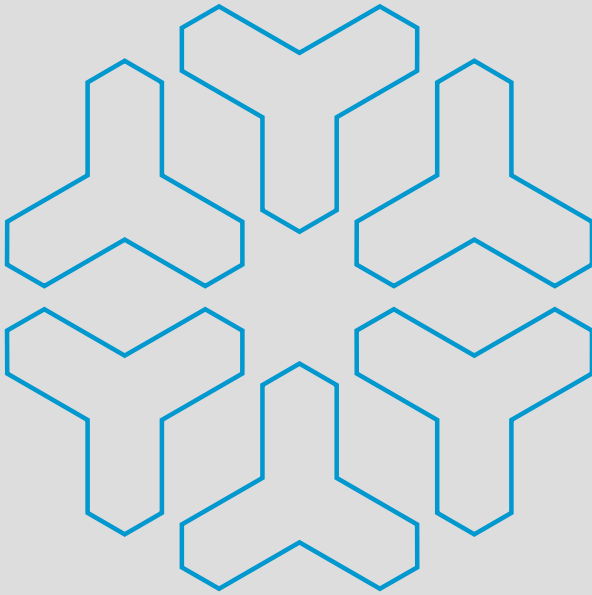

The warranty card and conditions  
are effective only in the area of Poland.

The package should be removed according  
to the regulations of environmental protection.



**RA****PA**

**"RAPA" S. Międlar W. i I. Szymańscy sp. j.**  
POLAND, 20-149 Lublin, 9 Ceramiczna Street  
BDO Reg. No 000009031  
tel. +48 81 718 46 50 / 51  
e-mail: rapa@rapa.lublin.pl

[www.rapa.pl/en](http://www.rapa.pl/en)