

**TRANSLATED
FROM ORIGINAL
USER MANUAL**

**FLOWER REFRIGERATOR
SCh – AK / AKM
SCh – AK / AKM Inverter**

EN

04/2024

Table of contents

1. Purpose and code meaning	4
2. Product characteristic	5
3. General information	5
4. Cooling system diagram	5
5. Transport and equipment	6
6. Wiring system	6
7. Wiring system diagram	7
8. Drawings	9
9. Maintenance	12
10. Positioning, start-up and operation	12
11. Temperature controller manual instruction	14
12. Interferences	18
13. Notes	18



Please read the user manual before using the flower refrigerator and keep the manual for future reference. Following the guidelines in the manual guarantees long-lasting, failure-free use of the device.



IT IS FORBIDDEN

1. Make repairs on your own and fail to comply with the rules contained in this manual regarding the connection and operation of the device;
2. Store substances that may explode in the device, such as aerosols filled with combustible propellants;
3. Place the device in the sun;
4. Covering the inlet and outlet of air from the aggregate;
5. **Switching the device on to the mains without a properly functioning protective circuit system;**
6. Use of extension cords and dividers to connect power.
7. Connect the devices to the mains without the protection pin.
8. Use devices/objects that could cause an electric spark inside the device and in the aggregate chamber.



WARNING!

1. **Incorrect connecting of the device to the mains may result in an electric shock.**
2. In the event of sparks or breakdowns, immediately disconnect the device from the power supply by pulling the plug from the socket and calling an authorized service technician.
3. It is necessary to protect the wiring system and control system against water and mechanical damage.
4. When servicing and replacing parts, the device must be disconnected from the power supply.
5. Power cord is connected directly with sockets mounted on the device. The aggregate and lighting switches do not disconnect current voltage into the socket.



CAUTION !

1. Before cleaning the condenser – **switch the device off!**
2. When cleaning the condenser, do not use tools/objects that could cause an electric spark.
3. **Particular attention should be paid to the distance between the flowers and the panoramic glass pane (min. 8 cm). Exceeding this limit may cause flowers to freeze.**
4. Water condensation on glass panes and sheets at high relative humidity (over 60%) is a natural phenomenon. Long-term and frequent occurrence of dewing indicates inadequate ambient conditions and is not a basis for calling the service!



The device is not intended for household use.
The device is not intended for outdoor use.

1. APPLICATION AND DEVICE CODE MEANING

The flower refrigerator is stationary-type equipment intended for storing and displaying cut flowers.

Device code meaning

Example of device code:

SCh – AK / 1605

SCh – type of the device: refrigerator





AK – model – flower refrigerator

AKM – model – modified flower refrigerator (for adjustable and for bucket shelves)

Width of the device [mm]:

1205, 1405, 1605, 1805, 2005, 2205

Important information on the rating label of each device:

FLOWER REFRIGERATOR		RAPA	
Device type: Sch - AK / XXXX			
Serial no:	XXXXXXXX	Voltage:	230V~ / 50Hz
Compressor no:	XXXXXX/X	Rated current (A):	XX
Controller no:	XXXXXXXX	Lighting:	LED
Compressor type:	XXXXXX	Heater power (W):	MAX.XXX
Refrigerant:	HC-290	Weight (kg):	XXX
Refrigerant amount (kg):	X,XXX	Usable capacity (l)	XXXX
Equivalent CO ₂ (f _{eq} CO ₂):	~ 0,0	Climatic class:	3
GWP factor	3	Temperature scope (°C):	+1 + +10
RAPA Sp. J. Ceramiczna 9 Street 20-149 Lublin POLAND Tel. +48 81 718 46 51			
   			

Name, logo and device type

Device technical parameters

Manufacturer contact details

In the case of contact with the service department, prepare the following data for efficient service:

- > device type,
- > serial no

These data are also given on the warranty card of the device.

Climatic class means the maximum ambient temperature at which the device works without disturbances.

Climatic class **3**

> maximum permissible ambient temperature of **+25°C**,

> temperature test:

ambient temperature **+25°C ± 1°C**

humidity **60% ± 3%**

2. PRODUCT CHARACTERISTICS

- > rated voltage: **230V~ / 50Hz**
- > refrigerant: **HC-290**; ODP = 0, GWP = 3
- > working temperature: **+1°C + +10°C**
- > sound pressure level: **<70dB (A)**



Width [mm]	Parameters					
	Usable width/depth (W x D) [mm]	Usable width/depth of hanging shelves* (W x D)	Usable width/depth of adjustable shelves* (W x D)	Usable capacity [l]	Stool dimensions (W x D x H) [mm]	LED power [W/m]
1205	1145x567	1125x200	1125 x 400	968	440x200x400	4,8
1405	1345x567	1325x200	1325 x 400	1154	540x200x400	4,8
1605	1545x567	1525x200	1525 x 400	1640	640x200x400	4,8
1805	1745x567	1725x200	1725 x 400	1535	740x200x400	4,8
2005	1945x567	1925x200	1925 x 400	1730	840x200x400	4,8
2205	2145x567	2125x200	2125 x 400	1900	940x200x400	4,8

* - optional equipment

W – width, D – depth, H - height

3. GENERAL INFORMATION

The flower refrigerator has a permanently fixed rating plate located on the top side part of the body. The body is made of H17 stainless steel sheet and profiles. The flower refrigerator's bottom is made of patterned H17 stainless steel sheet. It is illuminated by LED stripes. Low-E insulating glass panels are made of tempered glass. To ensure cooling the refrigerator has an energy-saving, sealed cooling system, automatically controlled and defrosted by an electronically controlled chamber thermostat, with a temperature display inside. The flower refrigerator has an automatic condensate evaporation system.

4. COOLING SYSTEM DIAGRAM

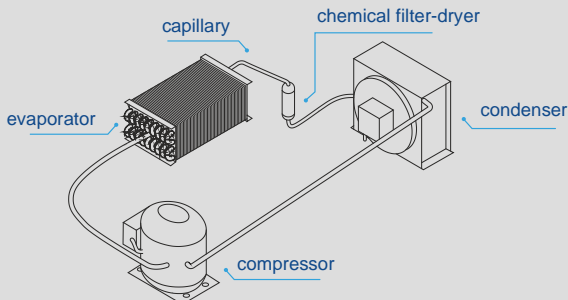

5. TRANSPORT AND EQUIPMENT

The supplied flower refrigerator is completely assembled. Secure the refrigerator during transport to prevent its overturning and breaking of the glass elements. When handling the refrigerator do not press the glass elements, do not grab the door or protective covers to lift the device. It is best to use belts and place them under the frame, between the feet (so that the belts do not slide). The flower refrigerator can be moved directly with a forklift truck without a pallet but it should be approached with caution.



Transport only in the operating position.

The flower refrigerator comes with:

- User Manual
- Stools for flowers – 2 pcs.
- condensate hose (Inverter version)
- Overflow condensate tray
- Crossbar for flower hangings

6. WIRING SYSTEM

1. The device is equipped with the protective PE cable.
2. Before connecting the device to the power supply, check the compatibility of the mains voltage with the device supplying voltage (data on the plate).
3. Connecting the device to the mains socket should be made so that the plug of the connecting cable is visible and easily accessible for the service.
4. The device should be connected to a separate, properly made electrical circuit protected by a fuse no greater than 10 A with a B-characteristic, ended with a socket with a protective pin.
5. The device may be started only after confirming the effectiveness of the shock protection with the results of measurements carried out in accordance with the applicable regulations.
6. Before carrying out any maintenance or cleaning, turn off the device with the switch and then remove the plug from the mains socket.
7. The device is started after connecting the plug to the mains socket, and then by turning on the switch. The backlight of the switch indicates that the device has been turned on.
8. Any repair of electrical installation and replacement of the connection cable (only into original one available from the manufacturer) may be carried out by an authorized electrician only.

7. WIRING SYSTEM DIAGRAM

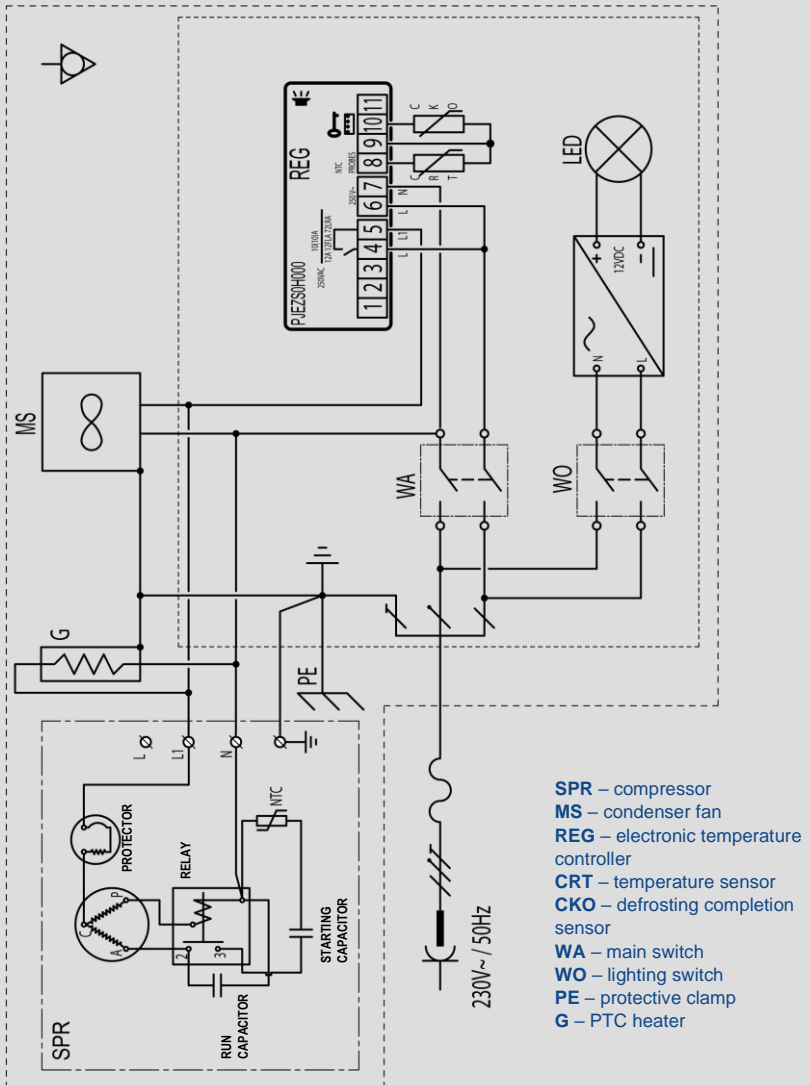

Wiring system SCh-AK/AKM with standard compressor (above)

Wiring system SCh-AK/AKM with Inverter compressor (below)

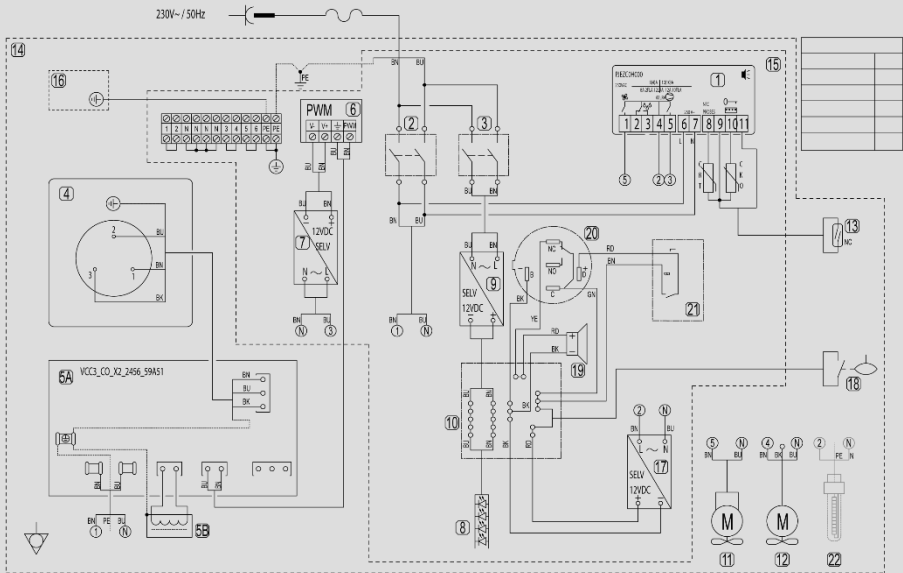

- 1 – electronic temperature controller
 - 2 – main switch
 - 3 – lighting switch
 - 4 – compressor
 - 5 – frequency inverter
 - 6 – PWM speed controller
 - 7 – PWM controller driver
 - 8 – LED lighting
 - 9 – LED lighting driver
 - 10 – lighting electric box 12V DC
 - 11 – evaporator fan (3 or 4 pcs.)
 - 12 – condenser fan
 - 13 – reed switch (2 or 4 in series)
 - 14 – housing
 - 15 – switch case
 - 16 – housing cover
 - 17 – water level alarm driver
 - 18 – float reed switch
 - 19 – PIEZO signaller
 - 20 – PIEZO signaller switch
 - 21 – breaker
- Optional elements:
- 22 – PTC heater

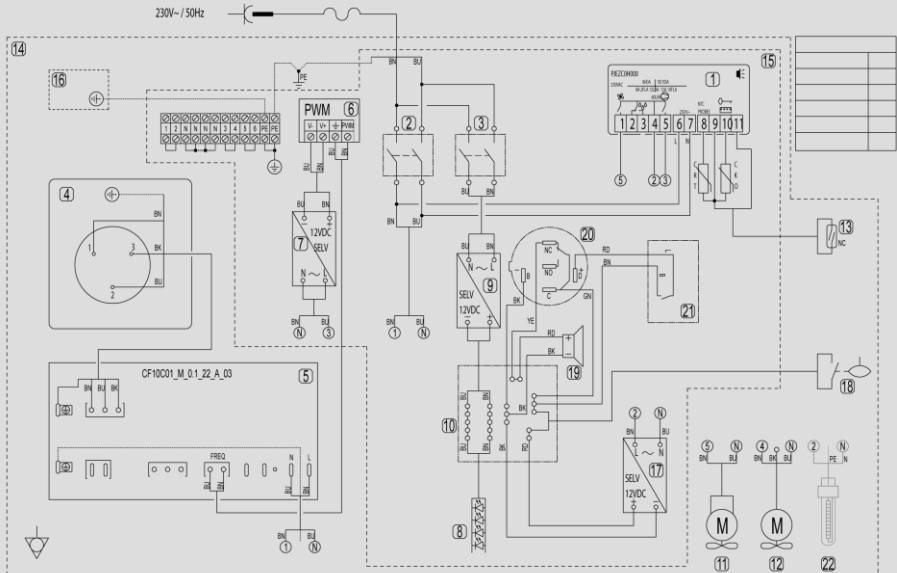

8. DRAWINGS

Fig. 1 Flower refrigerator (with standard compressor)

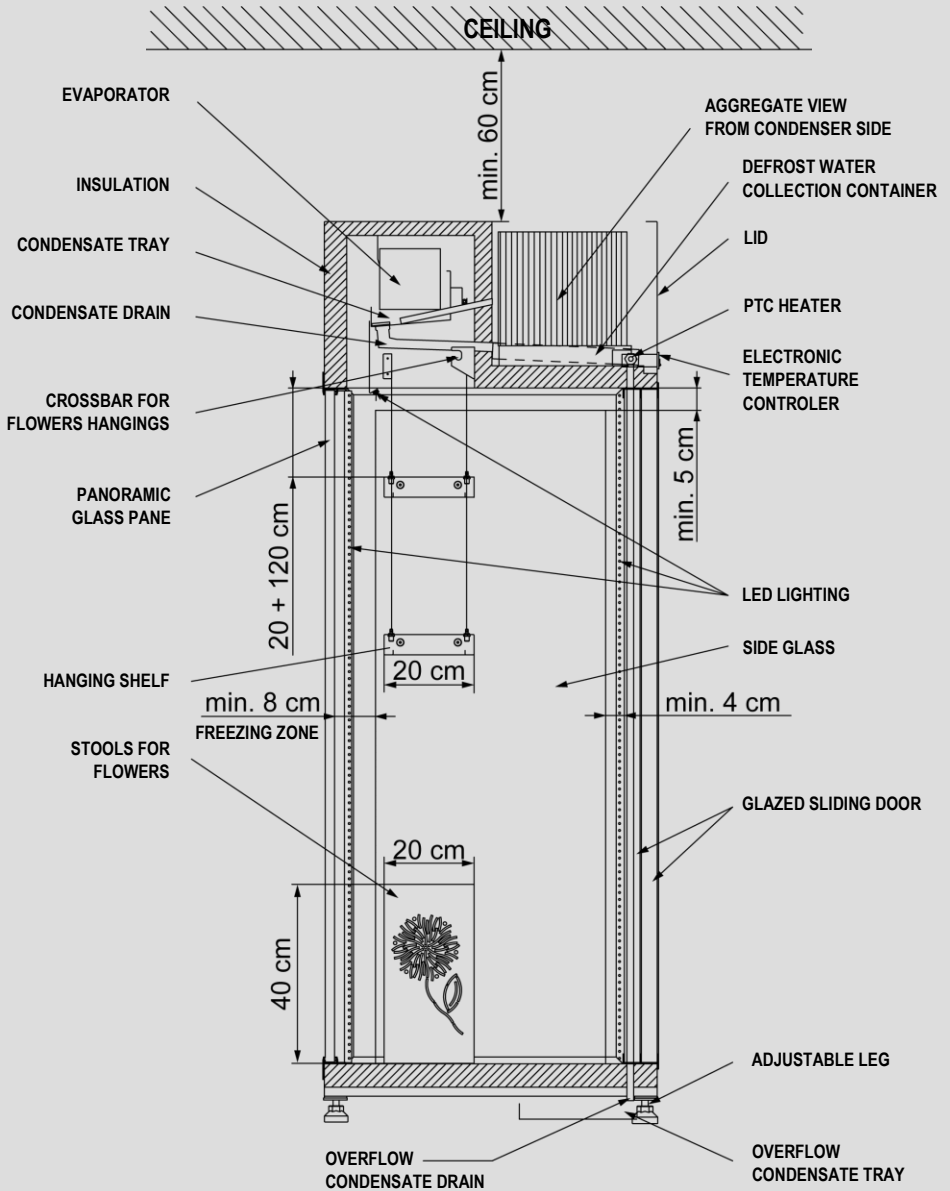

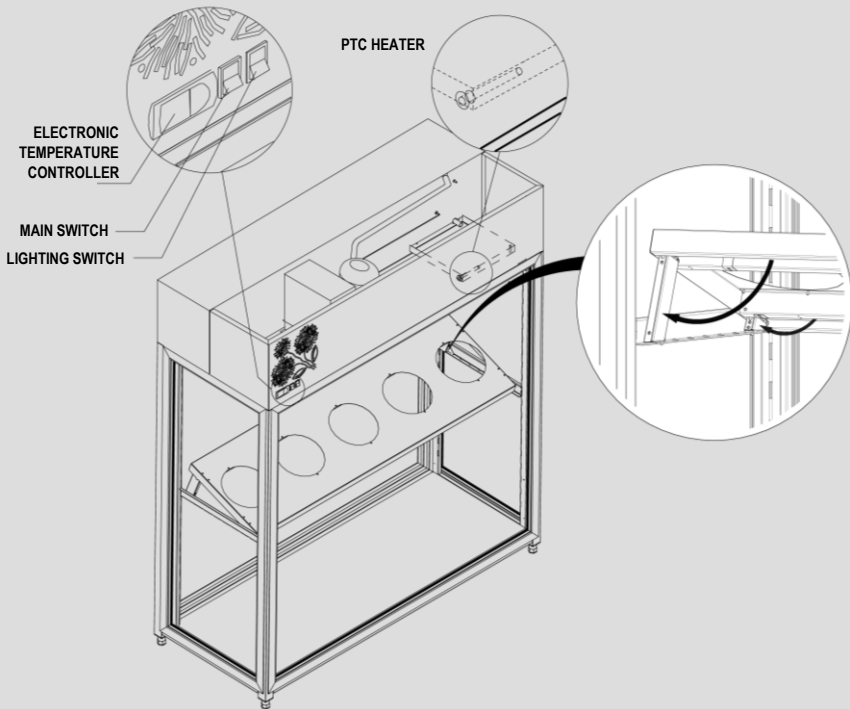
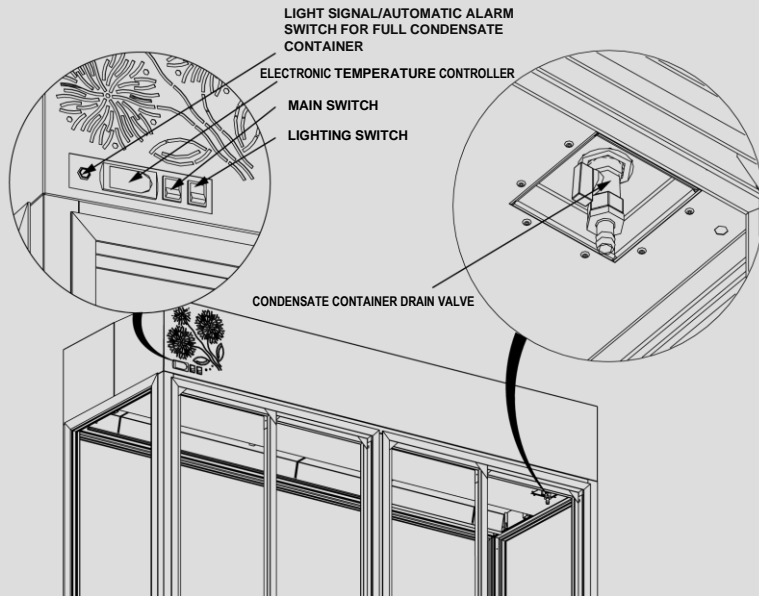

Fig. 2 Flower refrigerator (Inverter version)



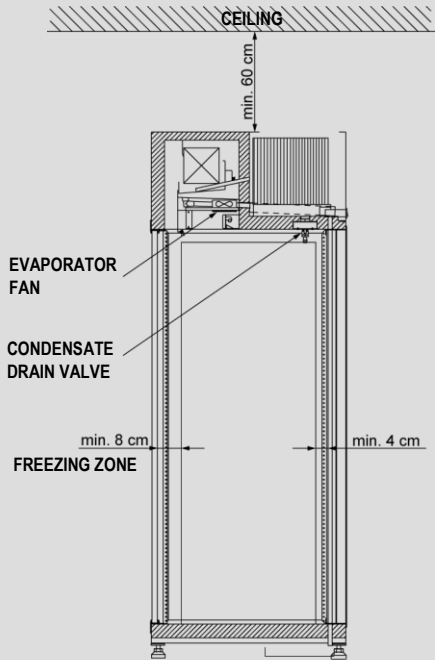
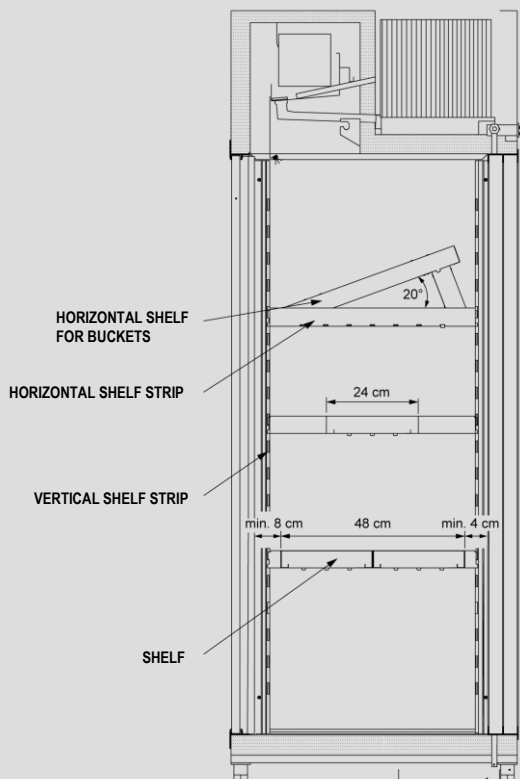

Fig. 3 Cross-section of a refrigerator for flowers with adjustable shelves.

1 shelf for buckets can be placed on each level – hole diameter 24,6 cm. The shelf can be set flat or at an angle of 20°.

Note: when positioning at an angle, pay special attention to ensure that the flowers are not in the low temperature zone (**8 cm**) from the side of the panoramic glass pane (see p. 10 of the User Manual).

On each level, you can install max. 2 shelves. There are locating / blocking holes in the horizontal strip to prevent the shelf from shifting.



9. MAINTENANCE

After disconnecting the device from power supply, the general maintenance should be done by the user, as follows:

1. washing with water of the temperature not more than +40°C with addition of natural cleaning agents. **To wash and clean the device it is forbidden to use agents containing of chlorine and sodium of various varieties, which destroy the protective layer and components of the device!** Any residual glue or silicone on the metal parts of the device should be removed only with gasoline (not applicable to plastic components!). Do not use other organic solvents.
2. removing impurities from the condenser by means of vacuum cleaner **(from up to down - along the fins)** at least once a month so that the flow of the cooling air through the condenser fins is not hampered.

Not following the above instructions causes increased energy consumption, decreased refrigeration efficiency of the device and eventually result in aggregate overheating, which consequently may lead to failure.

While cleaning the condenser be careful not to deform the fins. Do not wash the device with a water jet. It is not advisable to clean the condenser with a brush as it causes impurities penetration deep into the condenser fins and finally block the air flow completely.

For units with an automatic condensate evaporation system, clean the container (Fig. 1) every 2 weeks to prevent the formation of unpleasant odours.



CLEAN THE CONDENSER WITH A VACUUM CLEANER HERE!

10. POSITIONING, START-UP AND OPERATION

To ensure correct operation, the flower refrigerator should be placed in an area with a good air circulation, away from sources of heat and sunlight, free from dust (the device is not dustproof).

It is forbidden to cover the air inlet and outlet to and from the unit above the device (min. 60 cm) and in front of the device (min. 1 m).

Place the refrigerator vertically and connect it to the electrical power supply according to the guidelines in p. 6 "Wiring system". The manufacturer is not responsible for disturbances in device operation at temperatures below +16°C (defrosting cycle is too long) and over +25°C.

WARNING:

The device cannot be placed below the floor level (in a hollow).

The room in which the device is located must have a minimum cubature of 4 m³.

Actions before start-up

Position the refrigerator in the required location and make sure all the feet are fully screwed home (almost as far as they can go). Now unscrew the feet and, using a level, adjust the refrigerator until it is level.

Start-up and beginning operation

The cooling unit and lighting are switched on and off using the switches shown in Fig. 2. The temperature inside is adjusted by the thermostat, according to the instructions in p. 11. At the bottom of the device in a place the overflow container as shown in Fig. 1. It is used to collect excess water which may arise in case of failure of the condensate heater or other causes which led to the achievement of the level of the overflow in upper tray for condensate. After switching the refrigerator on, leave it empty until it switches off for the first time. Now it is ready to be filled with products.

Attention: The distance from flowers to the panoramic glass pane should be kept (8cm). Crossing this distance may cause flower freezing.

Flower refrigerator is equipped with:

- a) crossbar for hanging flowers which can load up to 10 kg,
- b) stools for flowers, maximum load of each stool is 50 kg.

Additionally, the device can be equipped with hanging shelves or adjustable shelves mounted on the side rails:

1. hanging shelves (Fig. 1) – you can load up to 20 kg each, but it should be evenly distributed over the entire surface of the shelves. It is possible to hang 3 shelves one under the other. It is allowed to hang 4 shelves, but the maximum load for each shelf should be reduced to 15 kg. The installation instructions are attached to the hanging shelves.
2. adjustable shelves / shelves for buckets (Fig. 3) – you can load up to 20 kg each, but it should be evenly distributed over the entire surface of the shelves. At the same time on one level (2 shelves on the same horizontal strip), you can put max. 35 kg.

The Inverter version of the flower refrigerator is equipped with a condensate level sensor in the condensate container, which informs about the need to empty the container by means of a light signal (flashing button backlight) on the front panel of the device (Fig. 2), and at the same time an audible signal. To empty the condensate container, you should:

1. remove the protective cap from the end of the valve, attach the drain hose to the end under the drain valve (Fig. 2),
(NOTE: when attaching the hose, hold the drain valve firmly),
2. place the other end of the hose in a container/bucket prepared for this purpose,
3. open the drain valve to empty the condensate container,
4. after the condensate has been released – close the valve, remove the hose and reattach the cap.

Repeat the operation each time the high condensate level alarm is activated. It is possible to turn off the audible signal by pressing the alarm switch (switch position pressed). The light signal will remain active until the tank is empty. In order for the sound signal to be active and to start after the next tank filling, press the alarm switch again (switch position pressed out). Before leaving the device (working) without the presence of the service for longer than 12 hours, the condensate container should be emptied – instructions as above. You can also insert a container of approx. 8-10 liters into the device and open the drain valve.

11. TEMPERATURE CONTROLLER MANUAL

DISPLAY DESCRIPTION

The display is three digits with decimal point and 6 symbols (compressor, fan, defrost, AUX, alarm and clock).

1. COMPRESSOR

The symbol is visible when the compressor operates. It flashes when the compressor's start up is delayed because of protective procedure. It flashes in the cycle: two flashes – break when there is continuous operation mode activated.

2. FAN

The symbol is visible when there are evaporator fans switched on. It flashes when the fans start-up is delayed by means of external switching off or when there is other procedure in progress.

3. DEFROST

The symbol is visible when there is defrost function switched on. It flashes when the defrost start-up is delayed by means of external switching off or when there is other procedure in progress.

4. AUX

The symbol is visible when there is additional AUX output activated.

5. CLOCK

The symbol is visible when there is clock switched on – switching on by means of „tEn” switch or when there is time limit set. When switching on the symbols appears for few seconds as clock function availability.

6. ALARM

The symbol is visible when there is alarm activated.

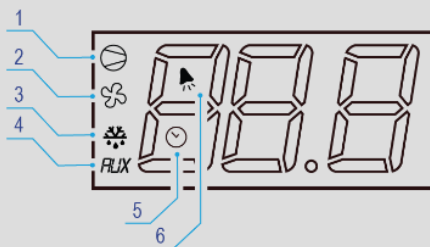

SWITCHES DESCRIPTION

Information: Short pressing of any of the switches causes appearance of message related to the currently active function.

7. UP / ON OFF

During normal operation of the controller; pressed for longer than 3 sec. will cause change of controller ON/OFF operation state, pressed along with the “DOWN” switch at the same time for longer than 3 sec. will cause activation or deactivation of continuous operation function (after pressing there will be shown on the display “CC” symbol). In the parameters setting mode: enable going to the next parameters settings. During setting parameter values: it causes parameter value increase.

8. SET / MUTE

Pressed during normal controller operation switches the alarm sound signal off; pressed for longer than 3 sec. shows setting point; pressed along with the “DOWN” switch at the same time while switching power supply of the controller on will cause return to the parameters fabric settings (there will be shown “CF” symbol on the display). In the parameters setting mode: its pressing changes the information shown on the display: parameter name/parameter value, pressed for longer than 3 sec. will cause saving of the set parameters. During setting parameter values: pressed it will cause saving of the entered parameter value.

9. DOWN / DEFROST

During normal operation of the controller; pressed for longer than 3 sec. will cause switching on/off of the manual defrost mode. In the parameters setting mode: it allows to go to previous parameter setting. During setting parameter values: it decreases setting value.

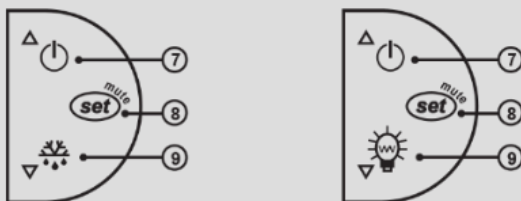

Set point setting (desired temperature value)

To view and modify the set point:

- > press the “SET” switch for 1 sec. – the set value will start flashing;
 - > increase or decrease the value using the “UP” or “DOWN” switches;
 - > press the “SET” switch to confirm the new value
- If the “SET” switch is not pressed for 60 sec., then the controller returns to previous settings.

Manual defrost

In order to activate the manual defrost press the “DOWN” switch for more than 3 sec. The essential condition is the temperature has to be lower than +6°C.

Temperature checking on the defrost probe

- > press the “SET” switch for longer than 3 sec. (in case there is the alarm is activated it is necessary to switch the sound alarm off first). On the display there will appear “PS” symbol (password);
- > go to the “d/” parameter by means of the “UP” and/or “DOWN” switches, then press the “SET” switch - there will appear temperature of defrost probe and the symbol ❄️ or 💡
- > hold the “SET” switch for longer than 3 sec. (after 60 sec. automatic return) – return to the temperature probe indication.

Access for operator to parameters configuration and its modification

- > press the „SET” switch for longer than 3 sec. (in case there is alarm activated, switch the sound alarm first). On the display will appear the „PS” symbol (service parameter password protected);
- > go to the next parameters by means of the “UP” and/or “DOWN” switches;
- > press the “SET” switch to view the current value of parameter setting;
- > increase or decrease setting value by means of the “UP” and “DOWN” switches;
- > press the “SET” switch to temporarily save the entered new value – it will cause as well return to the parameters list;
- > repeat the above operations – if it is necessary;
- > press and hold the “SET” switch for longer than 3 sec. – it will cause parameters saving and exit from the programming procedure.

Warning:

If no button is pressed for 60 sec., all the changes made to the parameters, temporarily saved in the RAM, will be cancelled and the previous settings restored.

If power is disconnected from the instrument before saving the settings (pressing the “SET” switch for 3 sec.), all the changes made to the parameters and temporarily saved will be lost.

Symbol	Parameter	Unit	Fabric setting	min.	max.
d8	Alarm bypass time after defrost	h	2	0	15
A0	Alarm and fan temperature differential	°C	2	0	20
AL	Absolute or relative temperature for low temperature alarm	°C	2	0	150
AH	Absolute or relative temperature for high temperature alarm	°C	8	0	150
Ad	Temperature alarm delay	min	60	0	199

High temperature alarm activation = setting + AH

High temperature alarm deactivation = setting + AH – A0

Low temperature alarm activation = setting – AL

Low temperature alarm deactivation = setting – AL + A0

Description of the main signals and alarms

LED flashing – The activation of the corresponding function is delayed by a timer

- > awaiting an external signal or disabled by another procedure that is already in progress. e.g. if is a continuous cycle in progress and a defrost is called, the latter will remain pending until the end of the continuous cycle, and the corresponding LED (defrost) will flash.

OFF flashing – state of the controller - OFF, to return to working mode (ON) press and hold ON/OFF button for more than 3 sec.

E0 steady – control probe error (1) – active sound signal:

- > probe not working: the probe signal is interrupted or short-circuited;
- > probe not compatible with the instrument.

The E0 alarm signal is constant when it is the only active alarm (the temperature value is not displayed).

E0 flashing – control probe error (1) – the alarm signal E0 is steady if it is the only active alarm (the temperature value is not displayed), while it flashes if other alarms are active or the second probe is displayed.

E1 flashing – evaporator probe error (2):

- > probe not working, the probe signal is interrupted or short-circuited;
- > probe not compatible with the instrument.

Ed flashing – The last defrost ended after exceeding the maximum duration rather than when reaching the end defrost set point. The message disappears when the next defrost ends correctly.

EF displayed during operation or on power-up – operating parameter reading error (controller automatic reset). Alarm reappearance after automatic reset – it is necessary to check the controller as there is no guarantee to keep the original precision of the operation.

EE – data errors – In certain operating conditions, the instrument may detect errors in the data saved. These errors may compromise the correct operation of the instrument. If the microprocessor detects a data saving error, the display shows the message “EE”. If the fault persists, the controller needs to be replaced. If, on the other hand, the message disappears, it can continue to be used. When “EE” error occurs frequently and/or remains for some time, the controller should be checked, as the original precision may not be guaranteed.

LO flashing – low temperature alarm. The probe has measured a temperature lower than the set point by a value that exceeds parameter AL:

- > check parameters AL, Ad and A0.

The alarm is automatically reset when the temperature returns within the set limits (see parameter AL).

HI flashing – high temperature alarm. The probe has measured a temperature higher than the set point by a value that exceeds parameter AH.

- > check parameters AH, Ad and A0.

12. INTERFERENCES

The most often occurring interferences of the device operation:

Reasons	Symptoms	Solution
Contaminated condenser	<ul style="list-style-type: none"> > Visible dust layer on the condenser fins, > hot air coming out of the aggregate chamber, > loud operation of the aggregate, > characteristic "clicking" coming out of the aggregate chamber every few minutes 	Before cleaning of the condenser it is necessary to switch the device off. Impurities on the condenser should be removed by means of vacuum cleaner equipped with brush, gently along fins to not to bend the lamella.
Device loaded with warm products	<ul style="list-style-type: none"> > hot air coming out of the aggregate chamber, > loud operation of the aggregate, > characteristic "clicking" coming out of the aggregate chamber every few minutes 	Goods loaded in the device chamber should be initially cooled up to maximum 4°C above the storage temperature .
Too high ambient temperature	<ul style="list-style-type: none"> > hot air coming out of the aggregate chamber, > loud operation of the aggregate, characteristic "clicking" coming out of the aggregate chamber every few minutes 	Ambient temperature for proper operation of the device should not exceed respectively: for 3rd climatic class +25°C.
Improper goods distribution in cooling chamber	<ul style="list-style-type: none"> > goods distributed not in accordance with the description in the user manual 	The goods should be placed as described in user manual .
External source of heat causing the abnormal operation of the device	<ul style="list-style-type: none"> > hot air coming out of the aggregate chamber, > loud operation of the aggregate, > characteristic "clicking" coming out of the aggregate chamber every few minutes 	External source of heat might be any other device that emits heat such as gas burner, heater, other device equipped with a refrigerated aggregate etc. It is necessary to pay attention if above mentioned examples may have influence on the deterioration of device operation conditions.

13. NOTES

1. Attempts to repair the device on your own and not following the instructions described in the user manual as for equipment connection and use will result in the device malfunction.
2. The device is using natural and ecological refrigerant R-290 (propane).



Warning! In case of damage of the cooling system the refrigerator should be immediately disconnected from the mains, any open sources of fire located close to the unit removed and the area carefully ventilated. Do not use electrical appliances inside the refrigerator.

3. The manufacturer is not liable for damages resulting from the use of the device in a manner inconsistent with the information contained in hereby user manual.

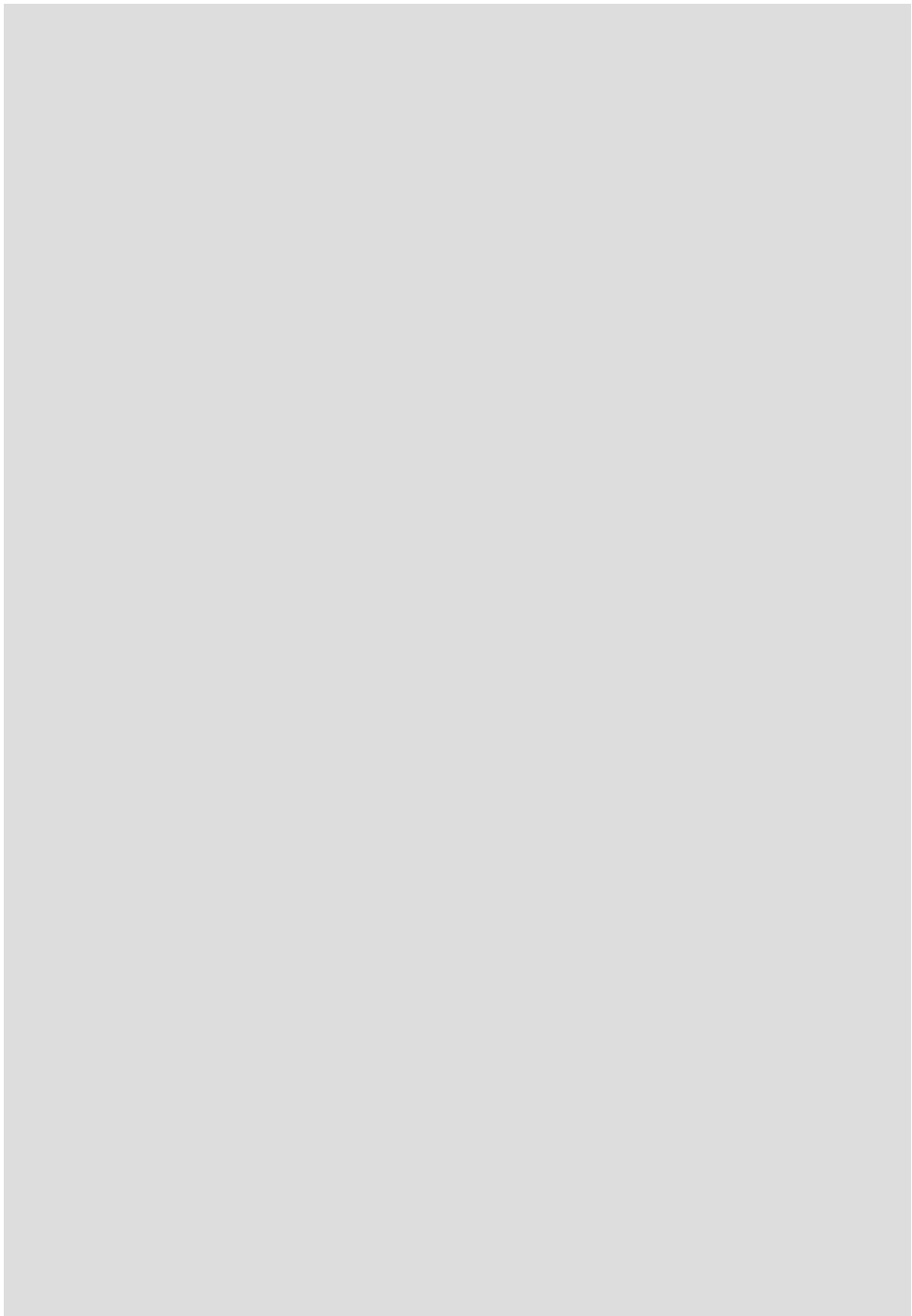

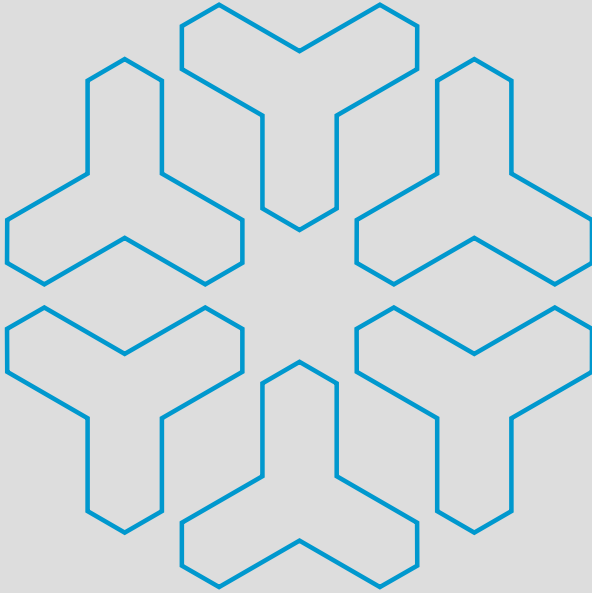

The warranty card and conditions
are effective only in the area of Poland.

The package should be removed according
to the regulations of environmental protection.



RAPA

RAPA S. Międlar W. i I. Szymański sp. j.
9 Ceramiczna Street, 20-149 Lublin, POLAND
Reg. no BDO 000009031
tel. +48 81 742 53 51
e-mail: rapa@rapa.lublin.pl

Service:
e-mail: service@rapa.pl

www.rapa.pl