

**TRANSLATED
FROM ORIGINAL
USER MANUAL**

**MODULAR MULTIDECK
REFRIGERATED DISPLAY**

RCh-O / RCh-SR

EN

12/2022

Table of contents

1. Application and device code meaning	4
2. Product characteristics	5
3. Cooling system diagram	5
4. Wiring system	5
5. Wiring system diagram	6
6. Drawings	7
7. Positioning, start-up and operation	9
8. Maintenance	10
9. Transport and equipment	11
10. Temperature controller manual	11
11. Interferences	15
12. Notes	15



Please read this user manual carefully before using the device and keep it for future reference. Following the manual's recommendations guarantees long-lasting and failure-free exploitation of the device.



IT IS FORBIDDEN

1. Make repairs on your own and fail to comply with the rules contained in this manual regarding the connection and operation of the device;
2. Store substances that may explode in the device, such as aerosols filled with combustible propellants;
3. Place the device in the sun;
4. Covering the inlet and outlet of air from the aggregate;
5. **Switching the device on to the mains without a properly functioning protective circuit system;**
6. Use of extension cords and dividers to connect power.
7. Connect the devices to the power socket without the protective pin.
8. Use devices/objects that could cause an electric spark inside the device and in the aggregate chamber.



WARNING !

1. **Incorrect connecting of the device to the mains may result in an electric shock.**
2. In the event of sparks or breakdowns, immediately disconnect the device from the power supply by pulling the plug from the socket and calling an authorized service technician.
3. Efficiency of the protective circuit of the electrical system should be checked by an authorized electrician.
4. It is necessary to protect the wiring system and control system against water and mechanical damage.
5. When servicing and replacing parts, the device must be disconnected from the power supply.



CAUTION !

1. Before cleaning the condenser – **switch the device off!**
2. When cleaning the condenser, do not use tools/objects that could cause an electric spark.
3. Water condensation on glass panes and sheets at high relative humidity (over 60%) is a natural phenomenon. Long-term and frequent occurrence of dewing indicates inadequate ambient conditions and is not a basis for calling the service!
4. Take care when removing the glass elements. Breaking the glass panes can cause injury!



The device is not intended for household use.

The device is not intended for outdoor use.

1. APPLICATION AND DEVICE CODE MEANING

The multideck refrigerated display is stationary-type device intended for storing and displaying food products (previously cooled) at a reduced temperature.

Device code meaning

Example of device code:

RCh-SR / 196 / 70





RCh – type of the device: multideck refrigerated display

O – model: open (without door, with night blind)

SR – model: sliding doors

196 / 70 – device dimensions (see table in p. 2)

Important information on the rating label of each device:

MULTIDECK REFRIGERATED DISPLAY		RAPA	
Device type: RCh-O / 133 / 70			
Serial no:	XXXXXXXX	Voltage:	230 V ~ / 50 Hz
Compressor no:	XXXXXX/X	Rated current (A):	XX
Controller no:	XXXXXXXX	Lighting:	XX
Compressor type:	XXXXXX	Weight (kg):	XXX
Refrigerant:	HC-290	Usable area (m ²):	XXX
Refrigerant amount (kg):	XXX	Climatic class:	3
Equivalent of CO ₂ (¹ _{eqCO₂}):	XX	Temperature scope (°C):	+2 ÷ +10
GWP factor:	3	Heater power (W):	XXX
„RAPA” sp. j Ceramiczna 9 Street 20-149 Lublin POLAND tel. +48 81 718 53 46 50			
Hermetically sealed     			

Name, logo and device type

Device technical parameters

Manufacturer contact details

In the case of contact with the service department, prepare the following data for efficient service:

- > device type,
- > serial no.

Climatic class means the maximum ambient temperature at which the device works without disturbances.

Climatic class **3**

> maximum permissible ambient temperature of **+25°C**,

> temperature test:
ambient temperature **+25°C ± 1°C**
relative humidity **60% ± 3%**

2. PRODUCT CHARACTERISTICS

- > rated voltage: **230V~ / 50Hz**
- > refrigerant: **HC-290**; ODP = 0, GWP = 3
- > operating temperature: **+2°C ÷ +10°C**
- > sound pressure level: **<70dB (A)**



Device / module* width [mm]	Device depth [mm]	Usable depth of the device [mm]	Usable width / depth of shelves [mm]	Usable exposition area [m ²]	LED power [W]
1330 / 1250	700	435	1220 / 342	2,23	20
1960 / 1880			930 / 342	3,36	25

* - refers to module dimensions (without glass sides – sides additionally 75mm)

3. COOLING SYSTEM DIAGRAM

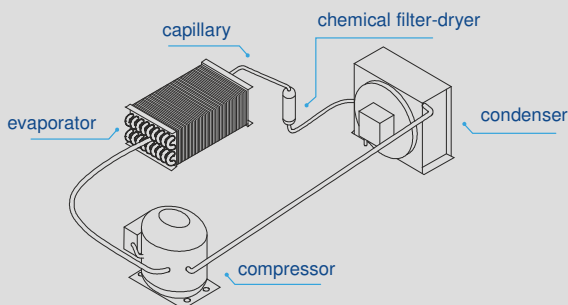

Fig. 1

4. WIRING SYSTEM

1. The device is equipped with the protective PE cable.
2. Before connecting the device to the power supply, check the compatibility of the mains voltage with the device supplying voltage (data on the plate).
3. Connecting the device to the mains socket should be made so that the plug of the connecting cable is visible and easily accessible for the service.
4. The device should be connected to a separate, properly made electrical circuit protected by a fuse no greater than 16 A with a B-characteristic, ended with a socket with a protective pin (for model RCh-SR / 125, 133 – not stronger than 10A).
5. The device may be started only after confirming the effectiveness of the shock protection with the results of measurements carried out in accordance with the applicable regulations.
6. Before carrying out any maintenance or cleaning, turn off the device with the switch and then remove the plug from the mains socket.
7. The device is started after connecting the plug to the mains socket, and then by turning on the switch. The backlight of the switch indicates that the device has been turned on.
8. Any repair of electrical installation and replacement of the connection cable (only into original one available from the manufacturer) may be carried out by an authorized electrician only.

6. DRAWINGS

Fig. 3

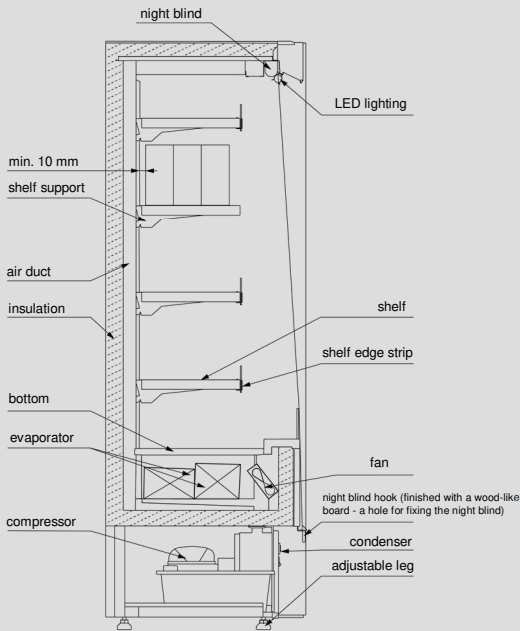
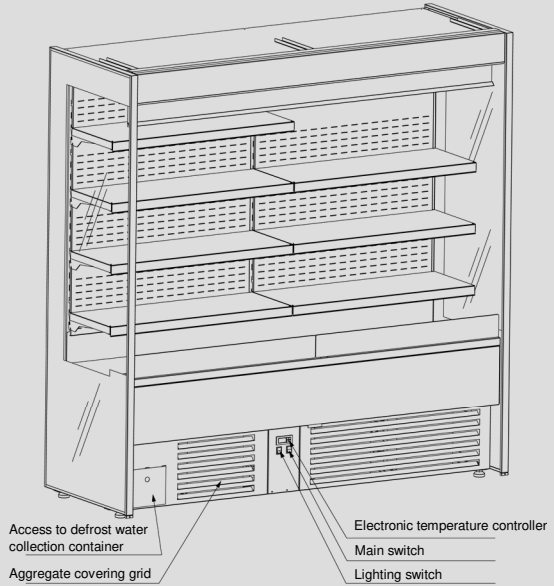

Fig. 4 Cross-section RCh-O

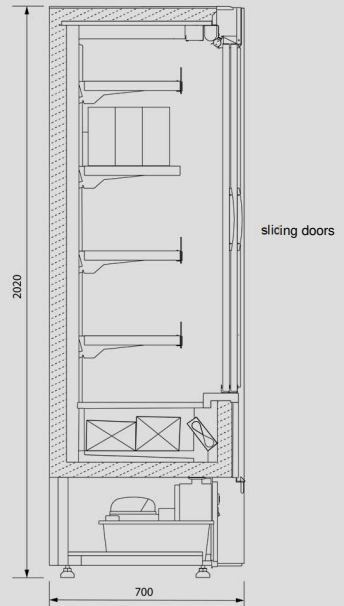

Fig. 5 Cross-section RCh-SR

It is possible to install crossbar closer to the back.
Only one crossbar is allowed to install on this type of bracket.

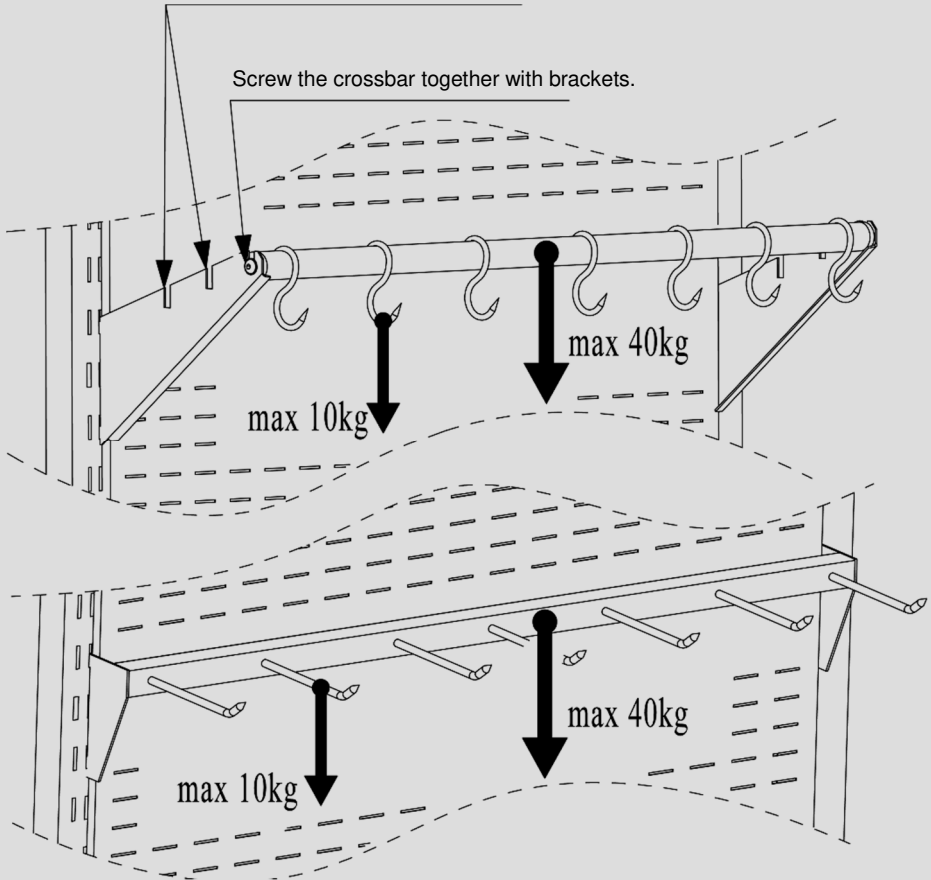

Fig. 6 Permissible load on the crossbar

Maximum load of the crossbar, spread evenly over the whole length – 40 kg but maximum load of one hook – 10 kg. It is allowed to install only three crossbars one below the other.

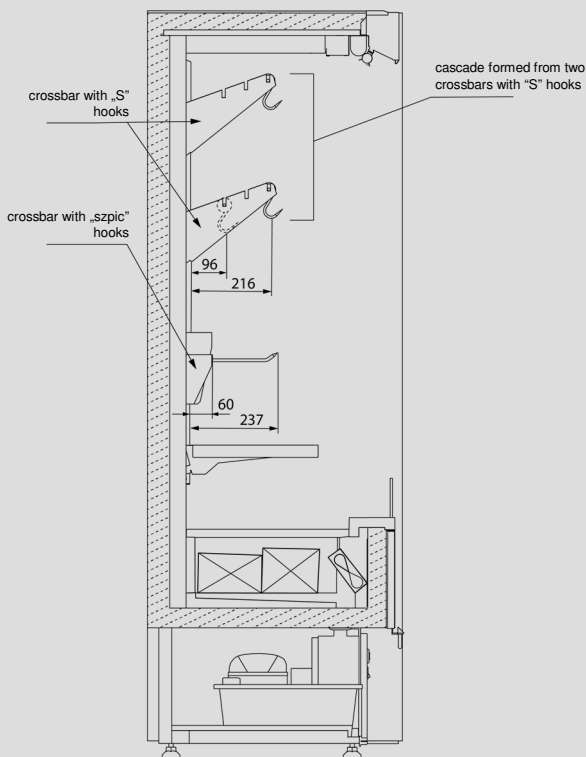

Fig. 7 Installation and dimensions of crossbars

7. POSITIONING, START-UP AND OPERATION

To ensure correct operation, the multideck refrigerated display should be placed in an area with a good air circulation, away from sources of heat and sunlight, free from dust (the device is not dustproof). It is forbidden to cover the air inlet to the unit (1 m) and the air outlet from the unit (rear of the device) while maintaining a minimum distance of 15 cm from the wall.

ATTENTION: if the device is placed in a niche, it is necessary to additionally ensure a distance of min. 30 cm on the side or top of the device to allow warm air to escape from the unit.

Place the device vertically and connect it to the electrical power supply according to the guidelines in p. 4 "Wiring system".

Actions before start-up

Place the device in the required location and make sure all the feet are fully screwed (almost as far as they can go). Then unscrew the feet and, using a level, adjust legs until the device is leveled. The device is equipped with a perforated night blind that must be lowered when the products are not exposed to reduce the power consumption. The night blind should be unrolled to the level of the upper edge of the ventilation grille, where there is a hook / hole for fixing it.

Start-up and beginning operation

The cooling unit and lighting are switched on and off using the switches shown in Fig 3. The temperature inside is adjusted by the temperature controller, according to the instructions in p. 10. After switching the device on, leave it empty until it turns off for the first time. Now it is ready to be filled with products. The condensate container should be emptied as needed.

Place the products on the shelves so that they do not protrude behind the shelf contour – this is necessary to ensure proper air circulation inside (Fig 4). The maximum shelf load is 30 kg.

Never put warm/hot products in the device because this causes an extended temperature increase inside the device and can even create a fault. A temperature increases after filling the multideck refrigerated display with warm/hot products is not evidence of a failure and does not constitute a basis for submitting a claim.

8. MAINTENANCE

After disconnecting the device from power supply, the general maintenance should be done by the user, as follows:

1. washing with water of the temperature not more than +40°C with addition of natural cleaning agents. **To wash and clean the device it is forbidden to use agents containing of chlorine and sodium of various varieties, which destroy the protective layer and components of the device!** Any residual glue or silicone on the metal parts of the device should be removed only with gasoline (not applicable to plastic components!). Do not use other organic solvents.

2. removing impurities from the condenser by means of vacuum cleaner (**from up to down - along the fins**) at least once a month so that the flow of the cooling air through the condenser fins is not hampered.

Not following the above instructions causes increased energy consumption, decreased refrigeration efficiency of the device and eventually result in aggregate overheating, which consequently may lead to failure.

While cleaning the condenser be careful not to deform the fins.

Do not wash the device with a water jet.

It is not advisable to clean the condenser with a brush as it causes impurities penetration deep into the condenser fins and finally block the air flow completely.



**CLEAN THE CONDENSERS
WITH A VACUUM CLEANER HERE**

9. TRANSPORT AND EQUIPMENT

Secure the device during transport to prevent its overturning, damage to the paint coating and breaking of the glass elements. When handling the device do not press the glass elements, do not grab the cooling unit protective grid to lift the device. Do not lift the refrigerator directly with a forklift truck or a pallet jack without a pallet, as this may damage the cooling unit.

The device must be transported in its operating position!

10. TEMPERATURE CONTROLLER MANUAL

DISPLAY DESCRIPTION

The display is three digits with decimal point and 6 symbols (compressor, fan, defrost, AUX, alarm and clock).

1. COMPRESSOR

The symbol is visible when the compressor operates. It flashes when the compressor's start up is delayed because of protective procedure. It flashes in the cycle: two flashes – break when there is continuous operation mode activated.

2. FAN

The symbol is visible when there are evaporator fans switched on. It flashes when the fans start-up is delayed by means of external switching off or when there is other procedure in progress.

3. DEFROST

The symbol is visible when there is defrost function switched on. It flashes when the defrost start-up is delayed by means of external switching off or when there is other procedure in progress.

4. AUX

The symbol is visible when there is additional AUX output activated.

5. CLOCK

The symbol is visible when there is clock switched on – switching on by means of „tEn” switch or when there is time limit set. When switching on the symbols appears for few seconds as clock function availability.

6. ALARM

The symbol is visible when there is alarm activated.

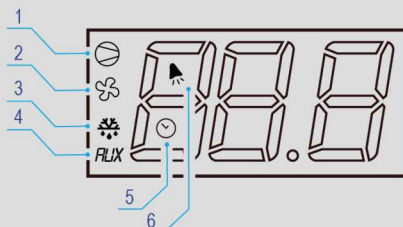

SWITCHES DESCRIPTION

Information: Short pressing of any of the switches causes appearance of message related to the currently active function..

7. UP / ON OFF

During normal operation of the controller; pressed for longer than 3 sec. will cause change of controller ON/OFF operation state, pressed along with the “DOWN” switch at the same time for longer than 3 sec. will cause activation or deactivation of continuous operation function (after pressing there will be shown on the display “CC” symbol). In the parameters setting mode: enable going to the next parameters settings. During setting parameter values: it causes parameter value increase.

8. SET / MUTE

Pressed during normal controller operation switches the alarm sound signal off; pressed for longer than 3 sec. shows setting point; pressed along with the “DOWN” switch at the same time while switching power supply of the controller on will cause return to the parameters fabric settings (there will be shown “CF” symbol on the display). In the parameters setting mode: its pressing changes the information shown on the display: parameter name/parameter value, pressed for longer than 3 sec. will cause saving of the set parameters. During setting parameter values: pressed it will cause saving of the entered parameter value.

9. DOWN / DEFROST

During normal operation of the controller; pressed for longer than 3 sec. will cause switching on/off of the manual defrost mode. In the parameters setting mode: it allows to go to previous parameter setting. During setting parameter values: it decreases setting value.

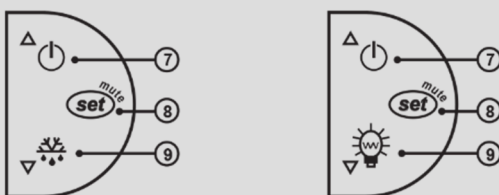

Set point setting (desired temperature value)

To view and modify the set point:

- > press the “SET” switch for 1 sec. – the set value will start flashing;
- > increase or decrease the value using the “UP” or “DOWN” switches;
- > press the “SET” switch to confirm the new value

If the “SET” switch is not pressed for 60 sec., then the controller returns to previous settings.

Manual defrost

In order to activate the manual defrost press the “**DOWN**” switch for more than 3 sec. The essential condition is the temperature has to be lower than +6°C.

Temperature checking on the defrost probe

- > press the “SET” switch for longer than 3 sec. (in case there is the alarm is activated it is necessary to switch the sound alarm off first). On the display there will appear “PS” symbol (password);
- > go to the “d/” parameter be means of the “UP” and/or “DOWN” switches, then press the “SET” switch - there will appear temperature of defrost probe and the symbol ❄ or ⚙
- > hold the “SET” switch for longer than 3 sec. (after 60 sec. automatic return) – return to the temperature probe indication.

Access for operator to parameters configuration and its modification

- > press the „SET” switch for longer than 3 sec. (in case there is alarm activated, switch the sound alarm first). On the display will appear the „PS” symbol (service parameter password protected);
- > go to the next parameters by means of the “UP” and/or “DOWN” switches;
- > press the “SET” switch to view the current value of parameter setting;
- > increase or decrease setting value by means of the “UP” and “DOWN” switches;
- > press the “SET” switch to temporarily save the entered new value – it will cause as well return to the parameters list;
- > repeat the above operations – if it is necessary;
- > press and hold the “SET” switch for longer than 3 sec. – it will cause parameters saving and exit from the programming procedure.

Warning:

If no button is pressed for 60 sec., all the changes made to the parameters, temporarily saved in the RAM, will be cancelled and the previous settings restored. If power is disconnected from the instrument before saving the settings (pressing the “SET” switch for 3 sec.), all the changes made to the parameters and temporarily saved will be lost.

Symbol	Parameter	Unit	Fabric setting	min.	max.
d8	Alarm bypass time after defrost	h	2	0	15
A0	Alarm and fan temperature differential	°C	2	0	20
AL	Absolute or relative temperature for low temperature alarm	°C	2	0	150
AH	Absolute or relative temperature for high temperature alarm	°C	8	0	150
Ad	Temperature alarm delay	min	60	0	199

High temperature alarm activation = setting + AH
High temperature alarm deactivation = setting + AH – A0

Low temperature alarm activation = setting – AL
Low temperature alarm deactivation = setting – AL + A0

Description of the main signals and alarms

LED flashing – The activation of the corresponding function is delayed by a timer
> awaiting an external signal or disabled by another procedure that is already in progress. e.g. if is a continuous cycle in progress and a defrost is called, the latter will remain pending until the end of the continuous cycle, and the corresponding LED (defrost) will flash.

OFF flashing – state of the controller - OFF, to return to working mode (ON) press and hold ON/OFF button for more than 3 sec.

E0 steady – control probe error (1) – active sound signal:

- > probe not working: the probe signal is interrupted or short-circuited;
- > probe not compatible with the instrument.

The E0 alarm signal is constant when it is the only active alarm (the temperature value is not displayed).

E0 flashing – control probe error (1) – the alarm signal E0 is steady if it is the only active alarm (the temperature value is not displayed), while it flashes if other alarms are active or the second probe is displayed.

E1 flashing – evaporator probe error (2):

- > probe not working, the probe signal is interrupted or short-circuited;
- > probe not compatible with the instrument.

Ed flashing – The last defrost ended after exceeding the maximum duration rather than when reaching the end defrost set point. The message disappears when the next defrost ends correctly.

EF displayed during operation or on power-up – operating parameter reading error (controller automatic reset). Alarm reappearance after automatic reset – it is necessary to check the controller as there is no guarantee to keep the original precision of the operation.

EE – data errors – In certain operating conditions, the instrument may detect errors in the data saved. These errors may compromise the correct operation of the instrument. If the microprocessor detects a data saving error, the display shows the message “EE”. If the fault persists, the controller needs to be replaced. If, on the other hand, the message disappears, it can continue to be used. When “EE” error occurs frequently and/or remains for some time, the controller should be checked, as the original precision may not be guaranteed.

LO flashing – low temperature alarm. The probe has measured a temperature lower than the set point by a value that exceeds parameter AL:

- > check parameters AL, Ad and A0.

The alarm is automatically reset when the temperature returns within the set limits (see parameter AL).

HI flashing – high temperature alarm. The probe has measured a temperature higher than the set point by a value that exceeds parameter AH. check parameters AH, Ad and A0.

11. INTERFERENCES

The most often occurring interferences of the device operation:

Reasons	Symptoms	Solution
Contaminated condenser	<ul style="list-style-type: none"> > Visible dust layer on the condenser fins, > hot air coming out of the aggregate chamber, > loud operation of the aggregate, > characteristic "clicking" coming out of the aggregate chamber every few minutes 	Before cleaning of the condenser it is necessary to switch the device off. Impurities on the condenser should be removed by means of vacuum cleaner equipped with brush, gently along fins to not to bend the lamella.
Device loaded with warm products	<ul style="list-style-type: none"> > hot air coming out of the aggregate chamber, > loud operation of the aggregate, > characteristic "clicking" coming out of the aggregate chamber every few minutes 	Goods loaded in the device chamber should be initially cooled up to maximum +4°C above the storage temperature .
Too high ambient temperature	<ul style="list-style-type: none"> > hot air coming out of the aggregate chamber, > loud operation of the aggregate, > characteristic "clicking" coming out of the aggregate chamber every few minutes 	Ambient temperature for proper operation of the device should not exceed respectively: for 3rd climatic class +25°C.
Improper goods distribution in cooling chamber	<ul style="list-style-type: none"> > high temperature of products 	The goods should be placed as described in user manual .
External source of heat causing the abnormal operation of the device	<ul style="list-style-type: none"> > hot air coming out of the aggregate chamber, > loud operation of the aggregate, > characteristic "clicking" coming out of the aggregate chamber every few minutes 	External source of heat might be any other device that emits heat such as gas burner, heater, other device equipped with a refrigerated aggregate etc. It is necessary to pay attention if above mentioned examples may have influence on the deterioration of device operation conditions.

12. NOTES

1. Attempts to repair the device on your own and not following the instructions described in the user manual as for equipment connection and use will result in the device malfunction.
2. The device is using natural and ecological refrigerant R-290 (propane).



**Warning! In case of damage of the cooling system the refrigerator should be immediately disconnected from the mains, any open sources of fire located close to the unit removed and the area carefully ventilated.
Do not use electrical appliances inside the refrigerator.**

3. The manufacturer is not liable for damages resulting from the use of the device in a manner inconsistent with the information contained in hereby user manual.

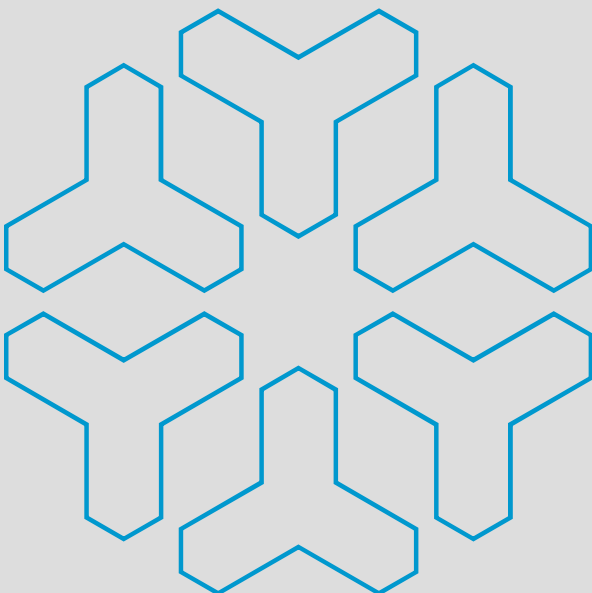

The warranty card and conditions
are effective only in the area of Poland.

The package should be removed according
to the regulations of environmental protection.



RA**PA**

„RAPA” S. Międlar W. i I. Szymańscy sp. j.
POLAND, 20-149 Lublin, 9 Ceramiczna Street
nr rej. BDO 000009031
tel. +48 81 742 53 10 do 14
e-mail: rapa@rapa.lublin.pl

Service:
tel. +48 81 718 46 08
e-mail: service@rapa.pl

www.rapa.pl/en