

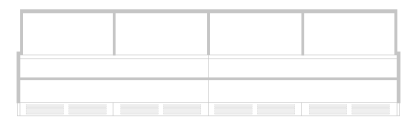

RA  **PA**
REFRIGERATION DEVICES MANUFACTURER

SiX

modern line
of refrigerated counters



RAPA

—

SiX

modern line
of refrigerated counters

SiX line is response to the challenges of the present day. The result of bold decisions bringing a new quality to the market of refrigerated counters. Thanks to the applied solutions, SiX refrigerated counters can be adapted to the individual preferences of our clients. Original colour variants and modern design create unique aesthetic solutions for commercial space.

The universal system of connecting the refrigerated counters facilitates the arrangement of the room and allows to effectively manage the available space.

Get inspired with new RAPA products - a combination of beauty and functionality, technology and art.





RA  PA















The SIX counters line allows to create any compositions of closed and open exposures – universal solution for every space.







model **S**

Refrigerated counter with curved front glass pane, opened up, version with front shelf.

The device with dynamic cooling equipped with a glass panes drainage system. Available in a version with a front shelf, stainless steel bumpers or in a minimalistic form without additives. A counter in the inoXtrame design with a stainless steel worktop, plastic sides and polyurethane insulation.

SiX



We present a new, inspirational collection of RAPA products. Now, the modern line of SiX refrigerated counters offers more than ever. One device and three solutions responding to different customer needs.

X model is a refrigerated counter with a modern, cubistic form with flat glass panes of keep increasing popularity, equipped with a convenient *lift-up* opening system. A similar system was applied in the S model with curved glass panes.

Xi and Si refrigerated counters complement the line with devices with short glass panes, with an open exposition for self-service spaces. All models are a coherent whole and can be combined with each other in various, interesting configurations.

SiX refrigerated counters are new colors, new materials, new technologies and attractive design that fits in with modern trends. All this is supported by many years of experience and the well-known reliability of RAPA devices.

Xi

Refrigerated counter with short front glass pane, version with bumpers.

The device with dynamic cooling equipped with a glass panes drainage system. Available in a version with a front shelf, stainless steel bumpers or in a minimalistic form without additives. A counter in the inoXtrame design with a stainless steel worktop, plastic sides and polyurethane insulation.





model X

Refrigerated counter with flat front glass pane, opened up.

The device with dynamic cooling equipped with a glass panes drainage system. Available in a version with a front shelf, stainless steel bumpers or in a minimalistic form without additives. A counter in the inoXtrame design with a stainless steel worktop, plastic sides and polyurethane insulation.

RA  PA

SiX

We know the needs of our clients, we know also how important diversity is, which is why the SiX line can be personalized by choosing dedicated fronts. Seven variants in the form of shiny steel lacquered in vivid, energetic colors or wood-derivative panels for the most demanding customers.

SiX is a combination of classic elegance and fresh look.

1. HONEYYELLOW RAL 1005 gloss
2. BLUE GREEN RAL 6004 gloss
3. RUBY RED RAL 3003 gloss
4. WHITE RAL 9003 gloss
5. BLACK RAL 9005 gloss
6. YOSEMITE S016
7. OAK CHARLESTON H3154

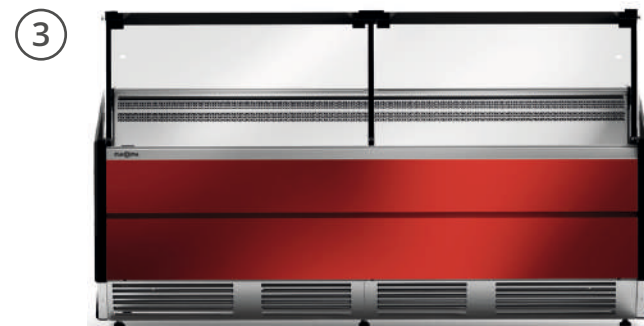
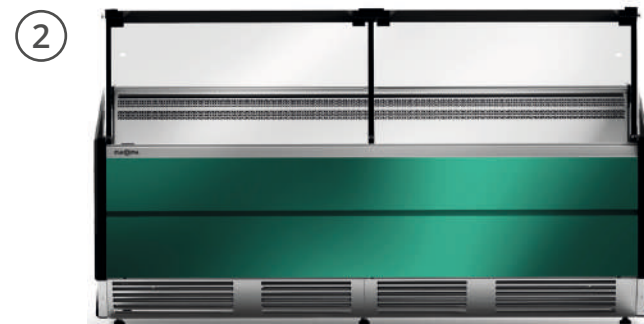
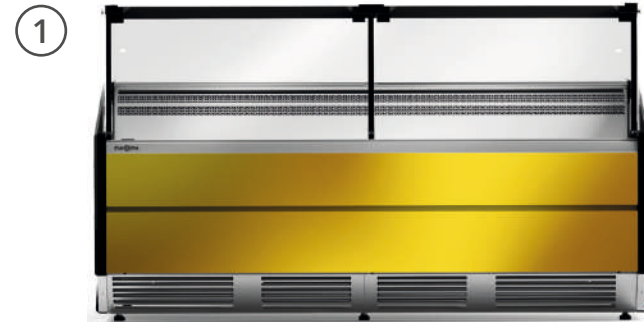

4

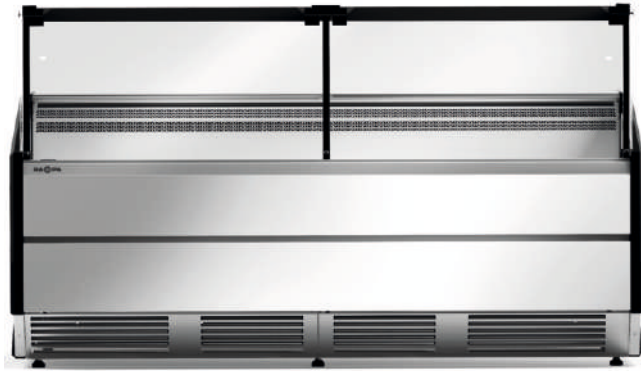

6



5



7



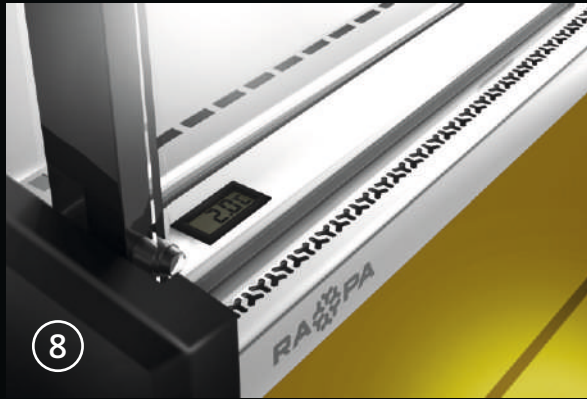
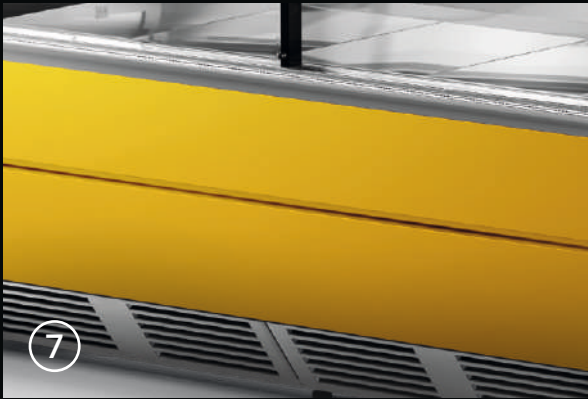
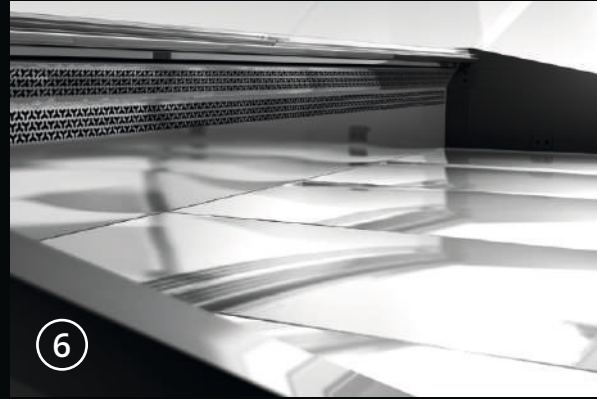
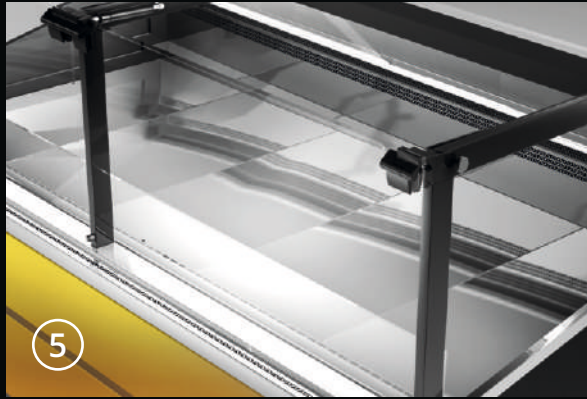
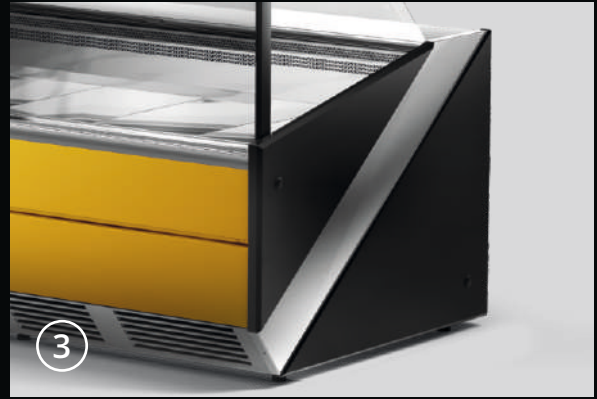
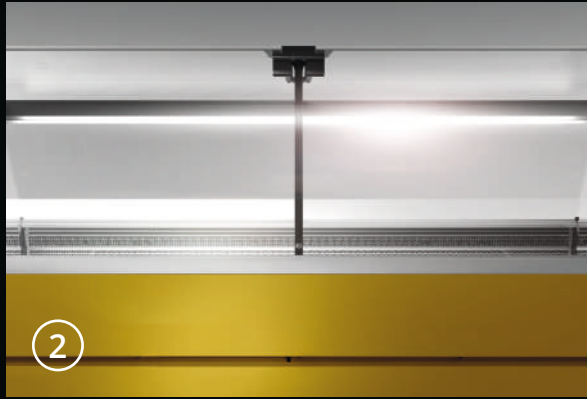
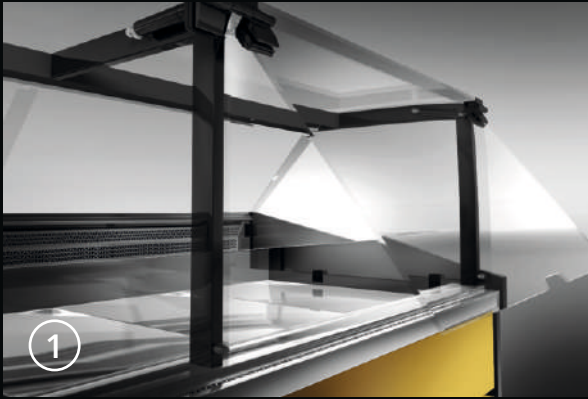

RA  PA

Six

1. glass panes opening system with *lift-up* type cylinders
2. LED lighting matched to products
3. inoXframe design
4. enlarged storage - from 4 pcs. up to 8 pcs. of Euro 2 containers
5. exposition area of the depth of 75 cm
6. dynamic cooling with a fan
7. exchangeable front panels in a wide range of colors
8. glass panes drainage system
9. high efficiency of the refrigeration system



RA  PA

SIX

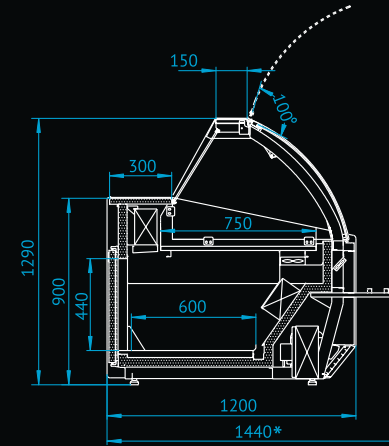

length

depth

height

exposition length

exposition depth

exposition height

temperatures range

refrigerant (HC)

rated voltage

defrosting

evaporation of condensate

* device depth with front shelf

S counter module

197 cm; 134,5 cm

187,5 cm; 125 cm

120 cm

120 cm

129 cm

129 cm

187,5 cm; 125 cm

187,5 cm; 125 cm

75 cm

75 cm

17 cm

17 cm

+1°C ÷ +10°C (3 cl.)

+1°C ÷ +10°C (3 cl.)

R-290

R-290

230 V~ / 50 Hz

230 V~ / 50 Hz

automatic

automatic

automatic

automatic

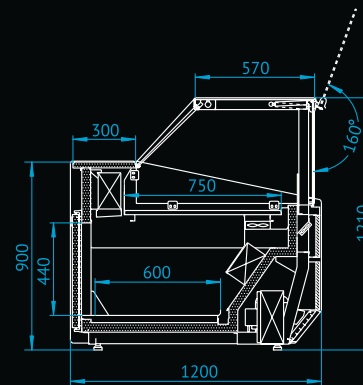
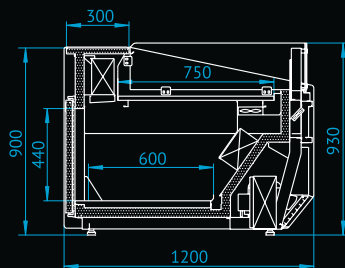
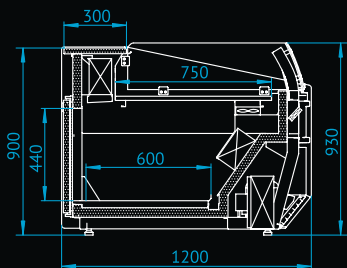

i

counter

module

197 cm; 134,5 cm	187,5 cm; 125 cm
120 cm	120 cm
93 cm	93 cm
187,5 cm; 125 cm	187,5 cm; 125 cm
75 cm	75 cm
17 cm	17 cm
+1°C ÷ +10°C (3 cl.)	+1°C ÷ +10°C (3 cl.)
R-290	R-290
230 V~ / 50 Hz	230 V~ / 50 Hz
automatic	automatic
automatic	automatic

X

counter

module

197 cm; 134,5 cm	187,5 cm; 125 cm
120 cm	120 cm
121 cm	121 cm
187,5 cm; 125 cm	187,5 cm; 125 cm
75 cm	75 cm
17 cm	17 cm
+1°C ÷ +10°C (3 cl.)	+1°C ÷ +10°C (3 cl.)
R-290	R-290
230 V~ / 50 Hz	230 V~ / 50 Hz
automatic	automatic
automatic	automatic



REFRIGERATION DEVICES MANUFACTURER

"RAPA" S. Międlar, W. i I. Szymańscy sp. j.
9 Ceramiczna Street, 20-149 Lublin POLAND

TIN PL 7121931385
BDO No. 000009031
KRS 0000005827

The "RAPA" company reserves the right to make changes in the characteristics and appearance of manufactured devices. The information provided in this catalogue is not binding and does not constitute an offer within the meaning of the Civil Code.



Unia Europejska
Europejski Fundusz
Rozwoju Regionalnego

